

Low Pass EMI Filters

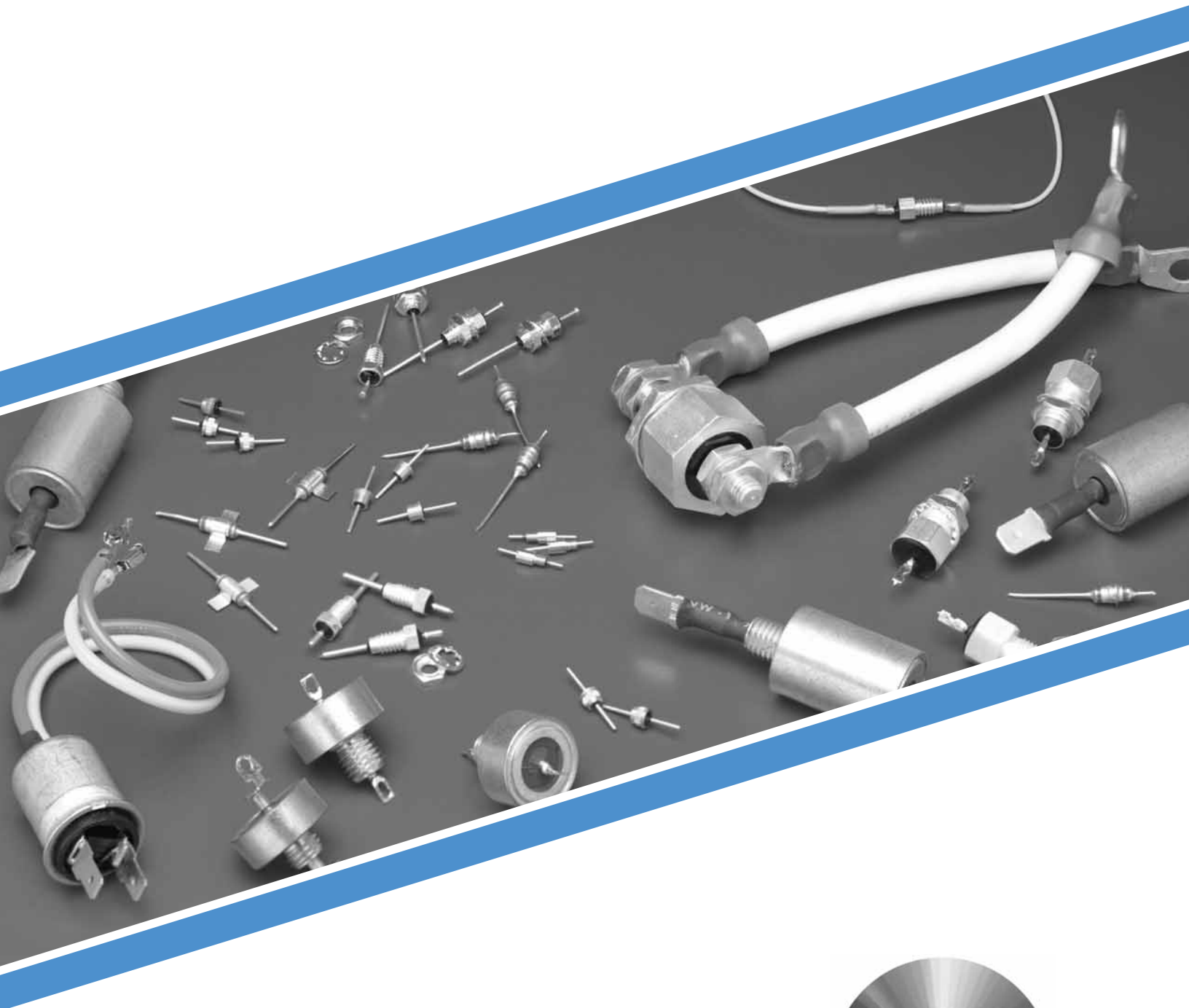

ISO 9001
CERTIFIED

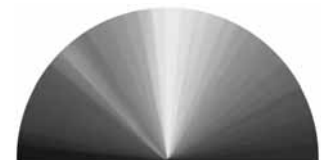

SPECTRUM CONTROL INC.
A Control Products and Systems Company
Signal and Power Integrity Group

Low Pass Filter Selection Guide

Other Key

Pages

Pages

Filter Installation	16
Performance Testing.....	17-18
Value Added Filter Assemblies	100
Military Cross Reference	237-239

MLFT Filters

- Performance through the GHz range
- Standard and custom mechanical packages available
- Transient voltage & surge protection available in some packages
- Available in multiple line packages

Motor Line Feed-Thru Technology (MLFT) is an innovative new line of filters designed to be a flexible, low cost solution to EMI (RF) noise issues. This product can be used in a variety of applications requiring high capacitance at lower voltages with the option of custom designed, easy to retro fit mechanical packaging.

MLFT Filters 65

Solder-in Filters

- Small size to allow effective use of space
- Voltage ratings to 750 VDC
- Multiple circuit configurations: C & Pi standard L circuit also available
- High temperature construction to prevent reflow during installation
- MIL-F-15733 QPL and MIL-C-11015 (CK99) filters available

Solder-in filters are ideal for use in critical areas where space does not allow use of mounting tools or hardware. The solder-in feature also allows installation in unison with other board mounted components. Primarily used in filtering signal/data lines and AC power lines.

Solder-in Filters

C	66-67
Pi	68-69
Miniature Solder-in Filters . . .	70

Resin Sealed Bolt-in Filters

- Wide range of sizes: 4-40 thread through 5/16-24 thread
- Voltage ratings to 500 VDC/220 VAC
- MIL-F-15733 QPL filters available
- Multiple circuit configurations: C, L and Pi
- Metric Threaded filters available
- Spec-Spin and Spec-Mini Press filters

These filters are easily mounted in a tapped hole or thru-hole with supplied nut and lock-washer. The rugged case with resin seals at both ends provides excellent environmental protection. Primarily used in filtering signal/data lines and DC power lines. The Spec-Mini Press and Spec Spin Filters are ideal for use where solder is undesirable. Each offers easy filter substitution and are for use in microwave applications and other high frequency applications.

Spec Mini-Press 9900 Series . . . 71

Spec Spin Filters 72

Resin Sealed Bolt-in Filters

4-40	73-75
6-32	76
6-40	76
8-32	77-78
10-32	79
12-28/32	80-82
5/16-24, 5/16-32	83

High Current/High Voltage Resin Sealed Filters

- Current ratings up to 100 Amps
- Continuous voltage ratings up to 2500 VDC/240 VAC
- U.L. 1459 recognized and CSA C22.2 certified versions available
- Rugged bolt-in style for easy installation

High current filters are ideal for use in high current 5 volt logic buss, but also can be used for +/-48 VDC telephone rack buss, high current switch mode power supplies and DC charging systems. High voltage filters find use in high voltage power supplies and applications requiring U.L. Hi-Pot.

High Voltage Filters

25 Amp	84-85
------------------	-------

UL/CSA Filters

50 Amp	84-85
100 Amp	84-85

Hermetically Sealed Case Filters

- Popular .375/.410" and .690" case diameters
- Voltage ratings from 50 VDC to 400 VDC/240 VAC
- Filter configurations available: C, L, Pi, T and double T
- MIL-F-15733 and MIL-F-28861 QPL filters available

This series of filters features hermetic glass seals and high EMI filtering performance. They are excellent for critical applications that demand high reliability in the toughest environmental conditions and provide broadband high performance EMI filtering from 10 KHz to over 10 GHz.

Case Dia.	Filter	
.375	C	87
	L	88-92
	Pi	93-94
	Transient Suppression	
	Pi	94
.410	T	95
	TT	96
	C	97
.690	L	98-99
	Pi	100
	T	101

MLFT Filters

Motor Line Feed-Thru Technology (MLFT) is an innovative new line of filters designed to be a flexible, low cost solution to EMI (RF) noise issues.

The product was originally developed to solve the filtering needs of DC motors, allowing them to pass the stringent standards that govern these motors in various industries they are used. Although this product was developed with the DC motors in mind, it can be used in almost any application that requires high capacitance at lower voltages with the option of custom designed, easy to fit mechanical packaging.

By utilizing our vast experience in designing, testing products at our on-site lab, and manufacturing integrated filtering products; we can quickly and economically design an easy to use solution to any EMC issue.

With easy installation in mind, our feed-thru packages are designed to be placed at the product's interface to the outside world at the low impedance ground — where filtering is optimized. Thus eliminating the need for complex PC boards that are required when trying to incorporate surface mount components and boards into a system.

Features

- Performance through the GHz range
- Standard and custom mechanical packages available
- Transient voltage & surge protection available in some packages
- Available in multiple line packages

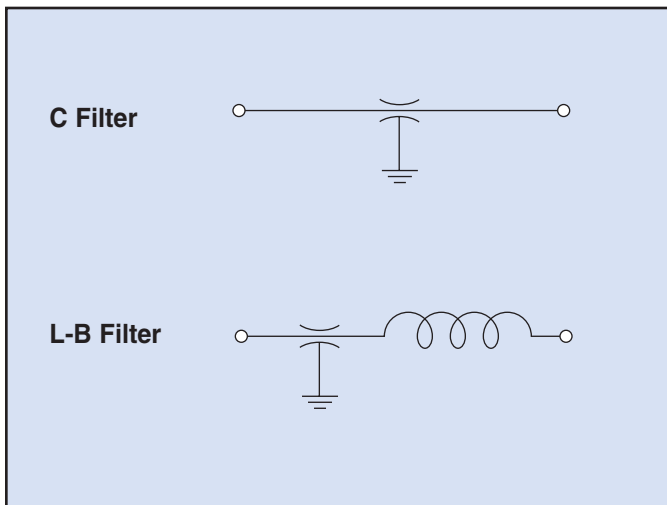

Solder-in Filters



Solder-in filters are ideal for use in critical areas where space does not allow use of mounting tools or hardware. The solder-in feature also allows installation in unison with other board mounted components. Primarily used in filtering signal/data lines and DC power lines.

Features

- Small size to allow effective use of space
- Voltage ratings to 750 VDC
- Multiple circuit configurations: C, L & Pi available
- High temperature construction to prevent reflow during installation
- MIL-F-15733 QPL versions available

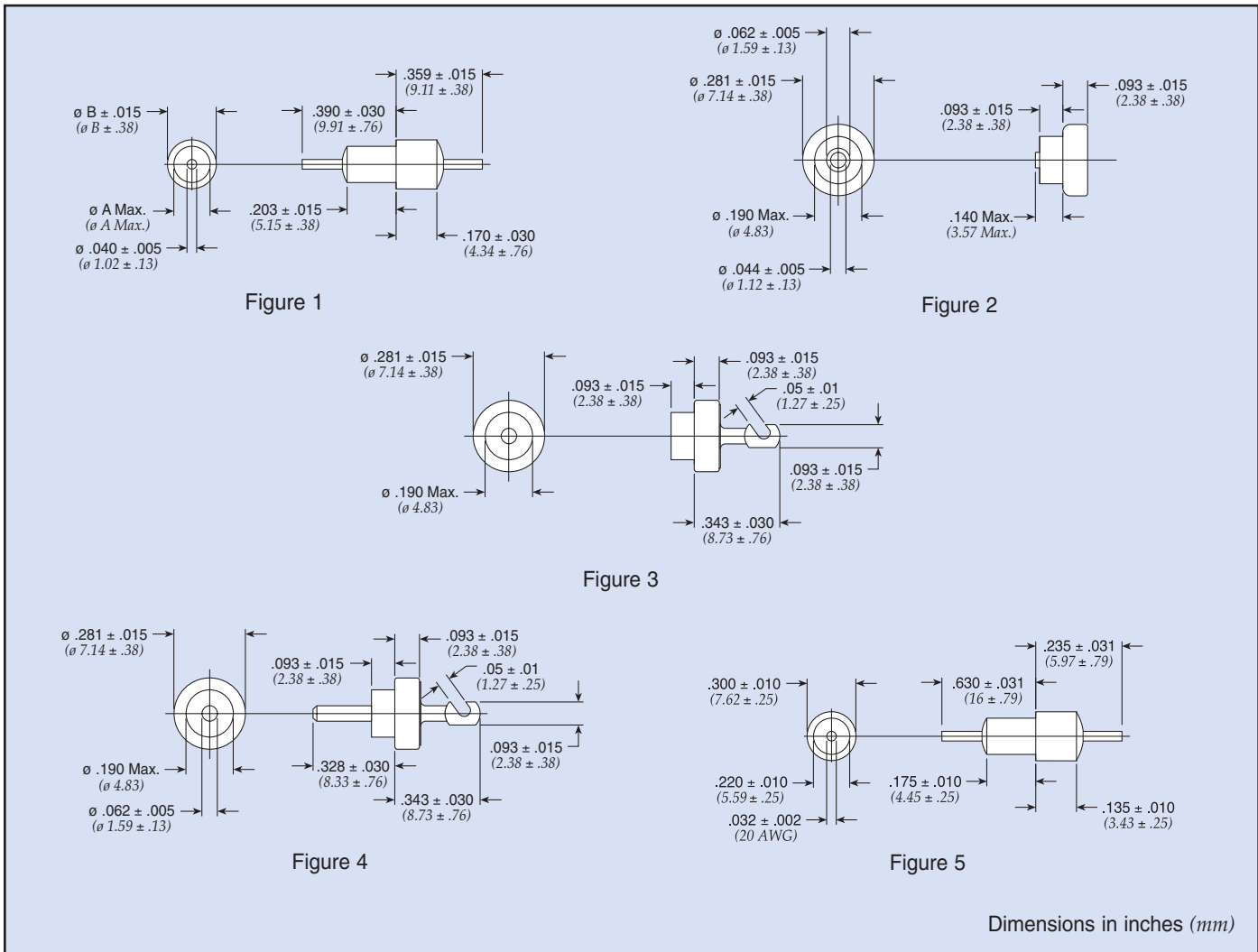

Solder-in Filters

Solder-in C Circuit

Part Number	See Pg. 64 for Fig.	A		B		Rated Voltage 125°C DC	I Amp	Cap*	Minimum Insertion Loss (dB)						
		In	(mm)	In	(mm)				1 MHz	10 MHz	30 MHz	100 MHz	300 MHz	1 GHz	10 GHz
54-786-003	1	0.156	(3.96)	0.203	(5.16)	50	10	0.30 μ F	32	47	54	60	66	70	70
54-785-002	1	0.125	(3.18)	0.184	(4.67)	100	10	0.05 μ F (min)	16	33	41	45	48	50	50
54794002X5R101M	4	—	—	—	—	250	25	100 pF \pm 20%	—	—	—	—	10	20	20
54803004X5R101M	3	—	—	—	—	250	25	100 pF \pm 20%	—	—	—	—	10	20	20
54802002X5R101M	2	—	—	—	—	250	25	100 pF \pm 20%	—	—	—	—	10	20	20
† 54794002X5R471M	4	—	—	—	—	250	25	470 pF \pm 20%	—	—	—	12	22	25	25
† 54803004X5R471M	3	—	—	—	—	250	25	470 pF \pm 20%	—	—	—	12	22	25	25
54802002X5R471M	2	—	—	—	—	250	25	470 pF \pm 20%	—	—	—	12	22	25	25
† 54802002X5V102P	2	—	—	—	—	250	25	1000 pF	—	—	—	15	25	35	40
† 54803004X5V102P	3	—	—	—	—	250	25	1000 pF	—	—	—	15	25	35	40
† 54794002X5V102P	4	—	—	—	—	250	25	1000 pF	—	—	—	15	25	35	40
† 54-786-077	5	—	—	—	—	750	10	1000pF	—	4	—	20	25	35	40

† Also available through Spectrum Control's authorized distributors.

* Tolerances are +100/-0% unless noted.

Solder-in Filters

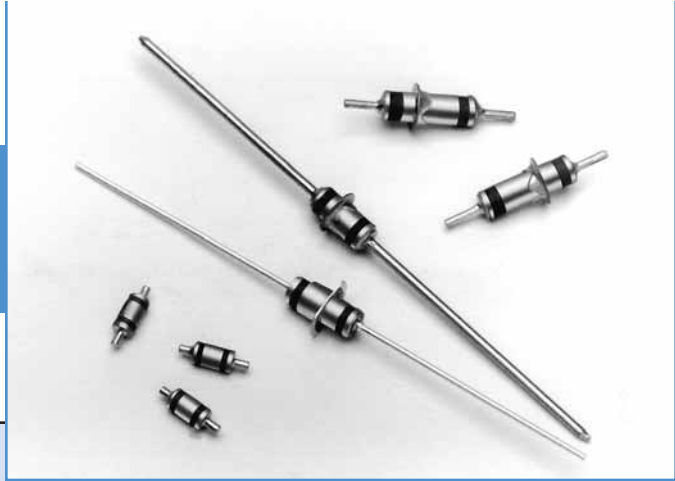

Solder-in Pi Circuit

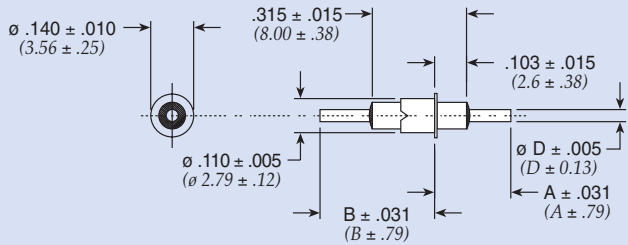

Figure 1

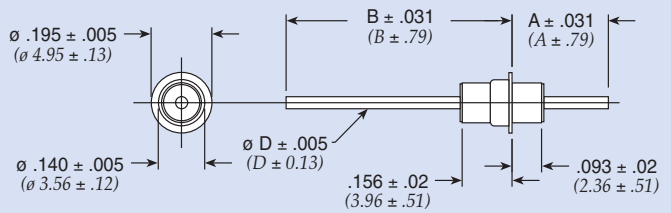

Figure 2

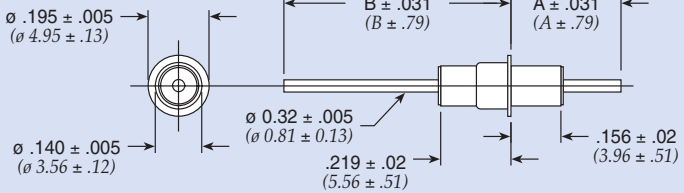

Figure 3

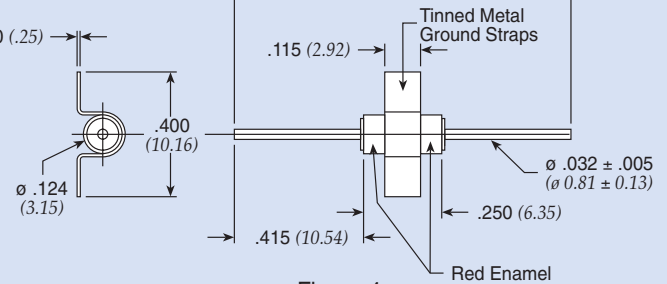

Figure 4

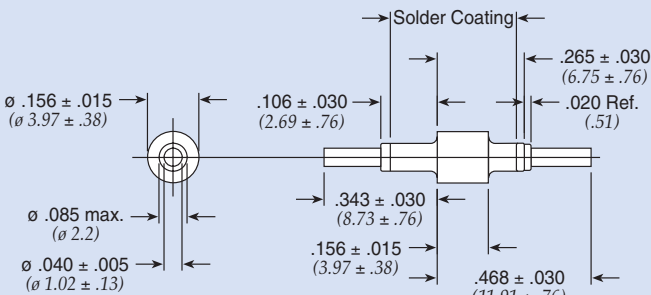

Figure 5

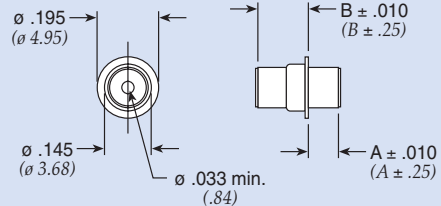

Figure 6

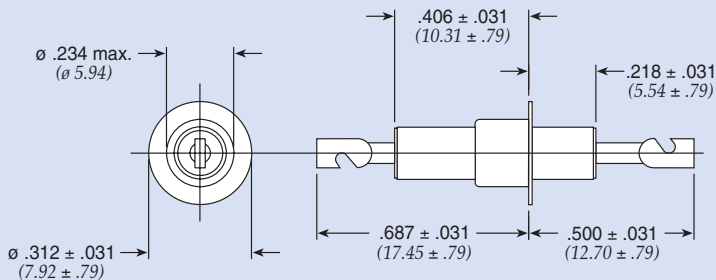

Figure 7

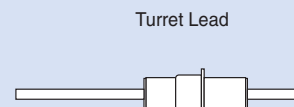

Figure 8

Dimensions in inches (mm)

Solder-in Filters

Solder-in Pi Circuit

Part Number	M15733 MIL Number	See Pg. 66 for Fig.	A		B		D		Rated Voltage 125°C		I Amp	Min Cap	Minimum Insertion Loss (dB)						
			In	(mm)	In	(mm)	In	(mm)	DC	AC			1 MHz	10 MHz	30 MHz	100 MHz	300 MHz	1 GHz	10 GHz
			51-703-013*	/62-0003	3	0.312	(7.92)	0.469	(11.91)	0.032			(0.81)	70	—	10	1500 pF	—	5
51-750-309*	/62-0004	2	0.268	(6.81)	0.780	(19.81)	0.032	(0.81)	70	—	10	0.012 µF	5	22	50	70	70	65	65
† 1234-000* €	—	2	0.257	(6.53)	0.780	(19.81)	0.032	(0.81)	70	—	10	0.012 µF	5	25	50	70	70	70	70
51-749-304	—	4	—	—	—	—	—	—	70	—	10	0.012 µF	5	25	50	70	70	65	65
1234-001	—	4	—	—	—	—	—	—	70	—	10	0.012 µF	5	25	50	70	70	65	65
† 51-750-301*	—	2	0.250	(6.35)	0.780	(19.81)	0.032	(0.81)	70	—	10	0.012 µF	5	25	50	70	70	70	70
† 1233-000* €	—	3	0.312	(7.92)	0.780	(19.81)	0.032	(0.81)	70	—	10	0.022 µF	7	35	60	70	70	70	70
† 51-750-302*	—	3	0.312	(7.92)	0.780	(19.81)	0.032	(0.81)	70	—	10	0.022 µF	7	25	60	70	70	70	70
51-750-313	/51-0002	3	0.312	(7.92)	0.780	(19.81)	0.032	(0.81)	70	—	10	0.022 µF	7	25	60	70	70	70	70
† 51-723-303	—	5	—	—	—	—	—	—	200	—	10	1300 pF	—	5	15	30	45	55	55
51-713-010	/62-0002	1	1.140	(28.96)	1.277	(32.44)	0.032	(0.81)	200	—	10	1500 pF	—	5	12	45	50	70	70
† 1251-001 €	—	1	1.109	(28.17)	1.206	(30.63)	0.032	(0.81)	200	—	10	1500 pF	—	5	15	40	50	70	70
51-703-001*	—	3	0.312	(7.92)	0.406	(10.31)	0.032	(0.81)	200	—	10	1500 pF	—	8	17	45	65	70	70
† 1203-050 €	—	3	0.312	(7.92)	0.406	(10.31)	0.032	(0.81)	200	—	10	1500 pF	—	5	15	45	50	70	70
51-703-012*	/62-0001	3	0.312	(7.92)	0.406	(10.31)	0.032	(0.81)	200	140	10	1500 pF	—	3	15	45	50	70	70
51-713-002	—	1	1.103	(28.01)	1.212	(30.78)	0.032	(0.81)	200	—	10	1500 pF	—	5	12	40	70	70	70
1214-029	—	2	0.288	(7.31)	0.780	(19.81)	0.032	(0.81)	200	—	10	1750 pF	—	5	15	50	60	60	70
† 1214-007 €	—	6	0.093	(2.36)	0.157	(3.99)	—	—	200	—	10	1750 pF	—	5	15	35	50	60	60
51-707-002*	—	2	0.288	(7.31)	0.780	(19.81)	0.032	(0.81)	200	—	10	1750 pF	—	8	17	50	65	70	70
† 1214-001*	—	2	0.288	(7.31)	0.780	(19.81)	0.032	(0.81)	200	—	10	1750 pF	—	5	15	50	50	60	60
† 51-707-006*	/33-0001	2	0.288	(7.31)	0.780	(19.81)	0.032	(0.81)	200	90	10	1750 pF	—	5	15	50	50	60	60
51-707-007	/33-0002	2	0.288	(7.31)	0.780	(19.81)	0.032	(0.81)	200	90	10	1750 pF	—	5	15	50	50	60	60
51-707-026	/66-0001	6	0.288	(7.31)	0.157	(3.99)	—	—	200	—	10	1750 pF	—	5	15	35	50	50	50
† 51-750-322	—	2	1.123	(28.52)	1.347	(34.21)	0.040	(1.02)	200	—	10	3000 pF	—	7	25	50	65	65	65
51-703-007*	/51-0001	3	0.312	(7.92)	0.406	(10.31)	0.032	(0.81)	200	200	10	5500 pF	—	15	30	55	65	70	70
1223-012	—	1	0.240	(6.10)	0.360	(9.14)	0.040	(1.02)	200	—	15	3000 pF	—	7	25	50	65	65	65
† 1204-050 €	—	7	0.210	(5.34)	—	—	—	—	500	—	25	3000 pF	—	8	25	50	65	70	70
51-704-002	/40-0001	7	0.234	(5.94)	—	—	—	—	500	350	25	3000 pF	—	7	25	55	65	70	70

* Denotes parts with turret on one end per Figure 8.
 † Also available through Spectrum Control's authorized distributors.
 € Also available through Spectrum Control's authorized European distributors/agents.

Miniature Solder-in Filters

These filters are ideal for microwave applications such as attenuators and oscillators, and perform well in high impedance circuits where large capacitance values are not practical.

Features

- Miniature size to allow effective use of space
- Standard capacitance values from 5pF to .030μF
- Voltage ratings to 200 VDC/115 VAC 0–400 Hz
- Hermetically sealed on one end allows for thru-hole sealing between compartments
- High temperature construction meets MIL-F-28861 solderability and resistance to soldering heat requirements
- Available in MIL-C-11015 versions — see page 239
- Gold plating compatible with gold bonding techniques

Marking

Color dot standard as follows:

- 101 Green – 100pF
- 272 Red – 2700pF
- 501 Brown – 500pF
- 502 Blue – 5000pF
- 102 Purple – 1000pF
- 153 Pink – 15000pF
- 122 White – 1200pF
- 000 None – 10pF max

Miniature Solder-in C Circuit

Part Number*	Figure	Rated Voltage 125°C		I Amp	Min Cap	Minimum Insertion Loss (dB)						
		DC	AC			1 MHz	10 MHz	30 MHz	100 MHz	300 MHz	1 GHz	10 GHz
SCI-9900-153	1	50		5	0.015 μF	7	25	30	40	40	60	60
SCI-9900-303	1	50		5	0.030 μF	10	30	35	45	50	55	55
† SCI-9910-272	1	100		5	2700 pF	—	10	18	25	33	40	50
† SCI-9910-502	1	100		5	5000 pF	—	15	20	30	35	45	55
SCI-9900-000	1	200		5	4 pF max.	—	—	—	—	—	10	10
† SCI-9920-101	1	200	115	5	100 pF	—	—	—	3	10	20	28
† SCI-9920-501	1	200	115	5	500 pF	—	—	—	15	22	35	40
† SCI-9920-122	1	200	115	5	1200 pF	—	5	10	20	28	35	45

* For reverse glass seal add an "R" to the end of the part number (SCI-9900-153R).

† Also available through Spectrum Control's authorized distributors.

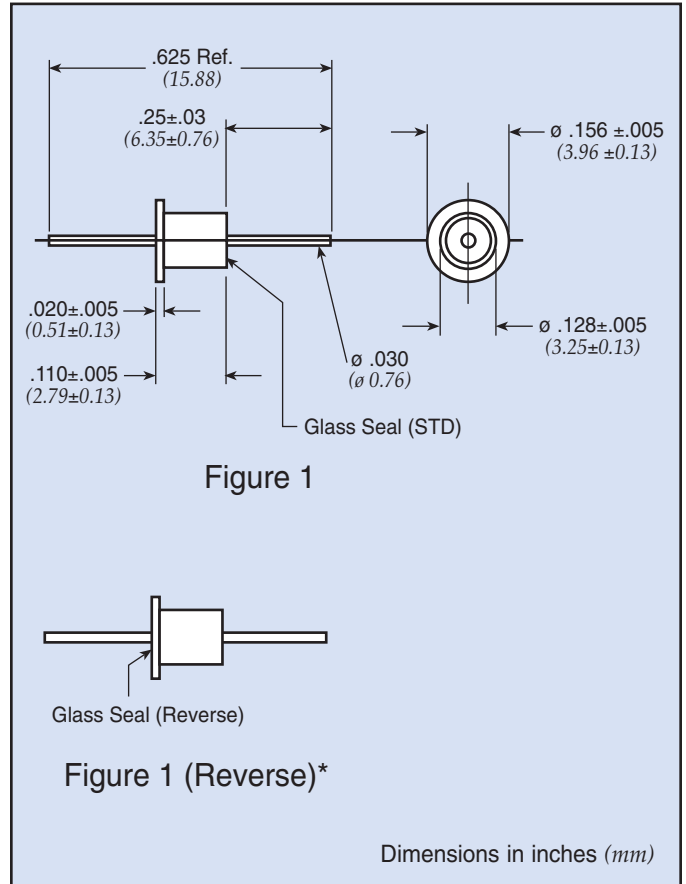

Resin Sealed Bolt-in Filters

These filters are easily mounted in a tapped hole or thru-hole with supplied nut and lock-washer. The rugged case with resin seals at both ends provides excellent environmental protection. Primarily used in filtering signal/data lines and DC power lines.



Features

- Wide range of sizes: 4-40 thread through 5/16-24 thread
- Voltage ratings to 500 VDC/220 VAC (400 Hz)
- MIL-F-15733 QPL filters available
- Multiple circuit configurations: C, L and Pi
- Metric threaded filters available, consult factory

4-40 C Circuit

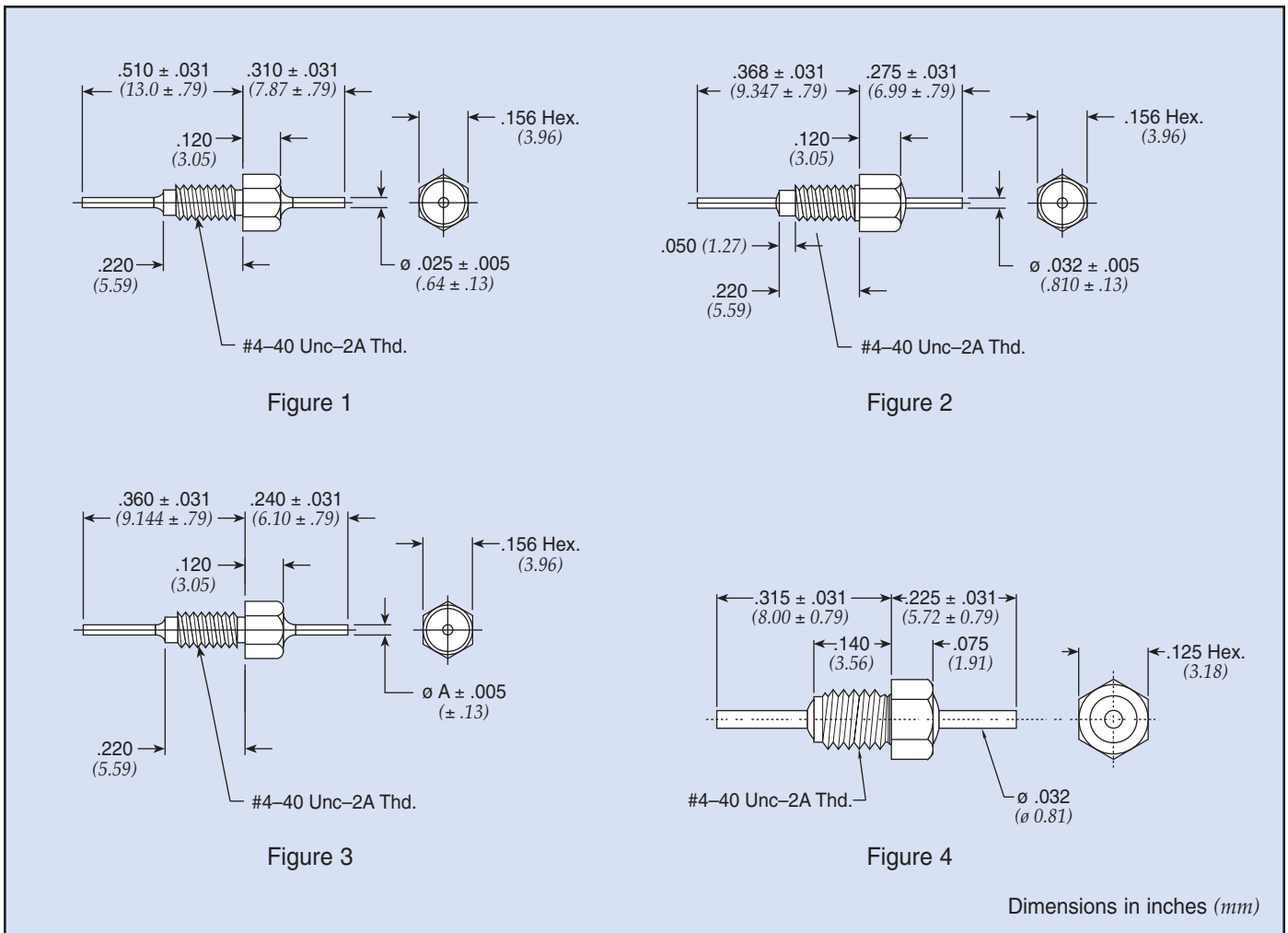

Resin Sealed Bolt-in Filters

4-40 C Circuit

Low Pass Filters

Part Number	See Pg. 71 for Fig.	Rated Voltage 125°C		I Amp	Min Cap	A		Minimum Insertion Loss (dB)								
		DC	AC			In	(mm)	1 MHz	3 MHz	10 MHz	30 MHz	100 MHz	300 MHz	1 GHz	10 GHz	
† SCI-9110-100	3	50	—	10	10 pF	0.032	(0.81)	—	—	—	—	—	—	—	10	10
† 9900-381-6004	2	50	—	10	5000 pF	—	—	—	—	15	22	30	35	45	55	
9900-381-6026	2	50	—	10	0.031 µF	—	—	12	20	25	35	40	45	55	60	
† 9900-381-6006	2	50	—	10	0.045 µF	—	—	14	22	30	40	45	50	55	60	
† 54-790-023	1	100	—	10	0.050 µF	—	—	15	24	34	41	45	50	60	60	
† 54790001X5F101M	1	100	—	10	100 pF ± 20%	—	—	—	—	—	—	—	10	20	25	
54-790-019	1	100	—	10	2700 pF	—	—	—	—	9	18	27	33	35	35	
9900-381-6013	2	100	—	10	2700 pF	—	—	—	—	10	18	25	33	40	50	
54-790-020	1	100	—	10	5600 pF	—	—	—	—	15	24	33	37	40	40	
SCI-9112-273	3	100	—	3	0.027 µF	0.016	(0.41)*	10	20	30	37	45	45	55	60	
SCI-9110-273	3	100	—	10	0.027 µF	0.020	(0.51)	10	20	30	37	45	45	55	60	
54-790-022	1	100	—	10	0.027 µF	—	—	10	20	30	37	45	50	55	60	
† SCI-9112-503	3	100	—	3	0.05 µF	0.016	(0.41)*	15	24	35	41	45	50	60	60	
SCI-9110-503	3	100	—	10	0.05 µF	0.020	(0.51)	15	24	35	41	45	50	60	60	
54-862-001	4	200	—	10	10 pF	—	—	—	—	—	—	—	—	10	10	
54-862-002	4	200	—	10	100 pF	—	—	—	—	—	—	3	10	20	28	
54-862-003	4	200	—	10	1000 pF	—	—	—	—	—	—	15	25	35	40	
† 9900-381-6020	2	200	—	10	100 pF	—	—	—	—	—	—	3	10	20	28	
SCI-9122-101	3	200	115	3	100 pF	0.016	(0.41)*	—	—	—	—	—	10	20	20	
SCI-9120-101	3	200	115	10	100 pF	0.020	(0.51)	—	—	—	—	—	10	20	20	
9900-381-6021	2	200	—	10	500 pF	—	—	—	—	—	—	15	20	35	40	
SCI-9122-102	3	200	115	3	1000 pF	0.016	(0.41)*	—	—	—	11	20	28	28	40	
SCI-9120-102	3	200	115	10	1000 pF	0.020	(0.51)	—	—	—	11	20	28	28	40	
† 9900-381-6022	2	200	—	10	1200 pF	—	—	—	—	5	9	20	28	35	45	
SCI-9122-502	3	200	115	3	5000 pF	0.016	(0.41)*	—	—	15	24	33	37	40	50	
SCI-9120-502	3	200	115	10	5000 pF	0.020	(0.51)	—	—	15	24	33	37	40	50	
SCI-9122-103	3	200	115	3	0.01 µF	0.016	(0.41)*	—	12	20	29	38	45	50	55	
SCI-9120-103	3	200	115	10	0.01 µF	0.020	(0.51)	—	12	20	29	38	45	50	55	
9900-381-6005	2	200	—	10	0.015 µF	—	—	7	9	20	29	35	45	50	60	
† 54-790-018	1	300	—	10	1000 pF	—	—	—	—	9	20	28	28	40		
† 54-790-021	1	300	—	10	0.01 µF	—	—	—	9	20	29	38	45	50	50	

* Tinned, steel leads.

† Also available through Spectrum Control's authorized distributors.

Resin Sealed Bolt-in Filters

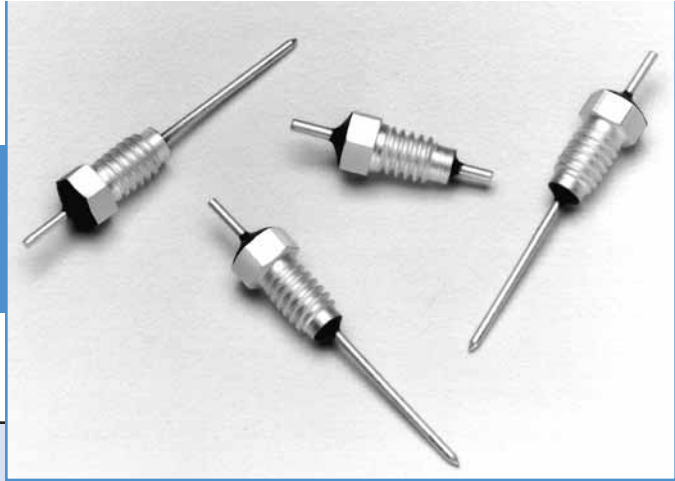

4-40 L and Pi Circuit

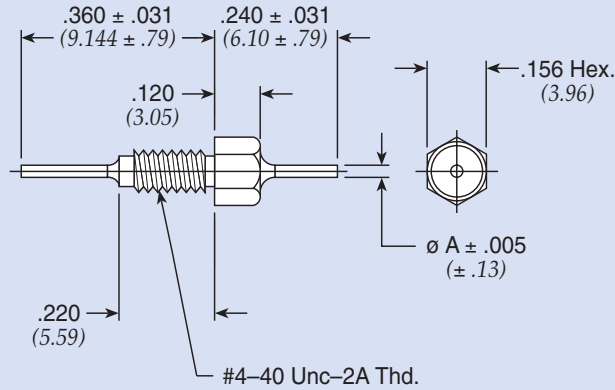

Figure 1

Dimensions in inches (mm)

Part Number	Figure	Rated Voltage 125°C		I Amp	CKT	Min Cap	A		Minimum Insertion Loss (dB)							
		DC	AC				In	(mm)	1 MHz	3 MHz	10 MHz	30 MHz	100 MHz	300 MHz	1 GHz	10 GHz
+51-729-305	1	50	—	3	Pi	5500 pF	0.018	(0.46)	—	7	14	40	60	70	70	70
+51-729-312	1	50	—	3	Pi	7000 pF	0.018	(0.46)	—	8	15	40	65	70	70	70
SCI-3102-002	1	50	—	3	LB	0.075 μF	0.016	(0.41)*	18	25	37	42	52	55	70	70
SCI-3102-000	1	50	—	5	LB	0.075 μF	0.016	(0.41)	18	25	37	42	52	55	70	70
SCI-3102-007	1	50	—	10	LB	0.075 μF	0.025	(0.64)	18	25	37	42	52	55	70	70
+51-729-304	1	100	—	3	LB	0.022 μF	0.018	(0.46)	7	17	27	34	43	47	55	55
+SCI-3112-002	1	100	—	5	LB	0.027 μF	0.016	(0.41)*	10	20	30	38	45	45	65	70
+SCI-3112-000	1	100	—	5	LB	0.027 μF	0.016	(0.41)	10	20	30	38	45	45	65	70
SCI-3112-007	1	100	—	10	LB	0.027 μF	0.025	(0.64)	10	20	30	38	45	45	65	70
SCI-3112-102	1	100	—	3	LB	0.05 μF	0.016	(0.41)*	15	24	35	42	54	56	70	70
SCI-3112-100	1	100	—	5	LB	0.05 μF	0.016	(0.41)	15	24	35	42	54	56	70	70
SCI-3112-107	1	100	—	10	LB	0.05 μF	0.025	(0.64)	15	24	35	42	54	56	70	70
+51-729-303	1	200	—	3	Pi	1500 pF	0.018	(0.46)	—	—	5	15	42	65	70	70
SCI-3122-002	1	200	115	3	LB	0.01 μF	0.016	(0.41)*	—	12	21	30	41	45	70	70
SCI-3122-000	1	200	115	5	LB	0.01 μF	0.016	(0.41)	—	12	21	30	41	45	70	70
SCI-3122-007	1	200	115	10	LB	0.01 μF	0.025	(0.64)	—	12	21	30	41	45	70	70

* Tinned, steel leads.

+ Also available through Spectrum Control's authorized distributors.

Resin Sealed Bolt-in Filters

6-32 C, L, Pi/6-40 Pi

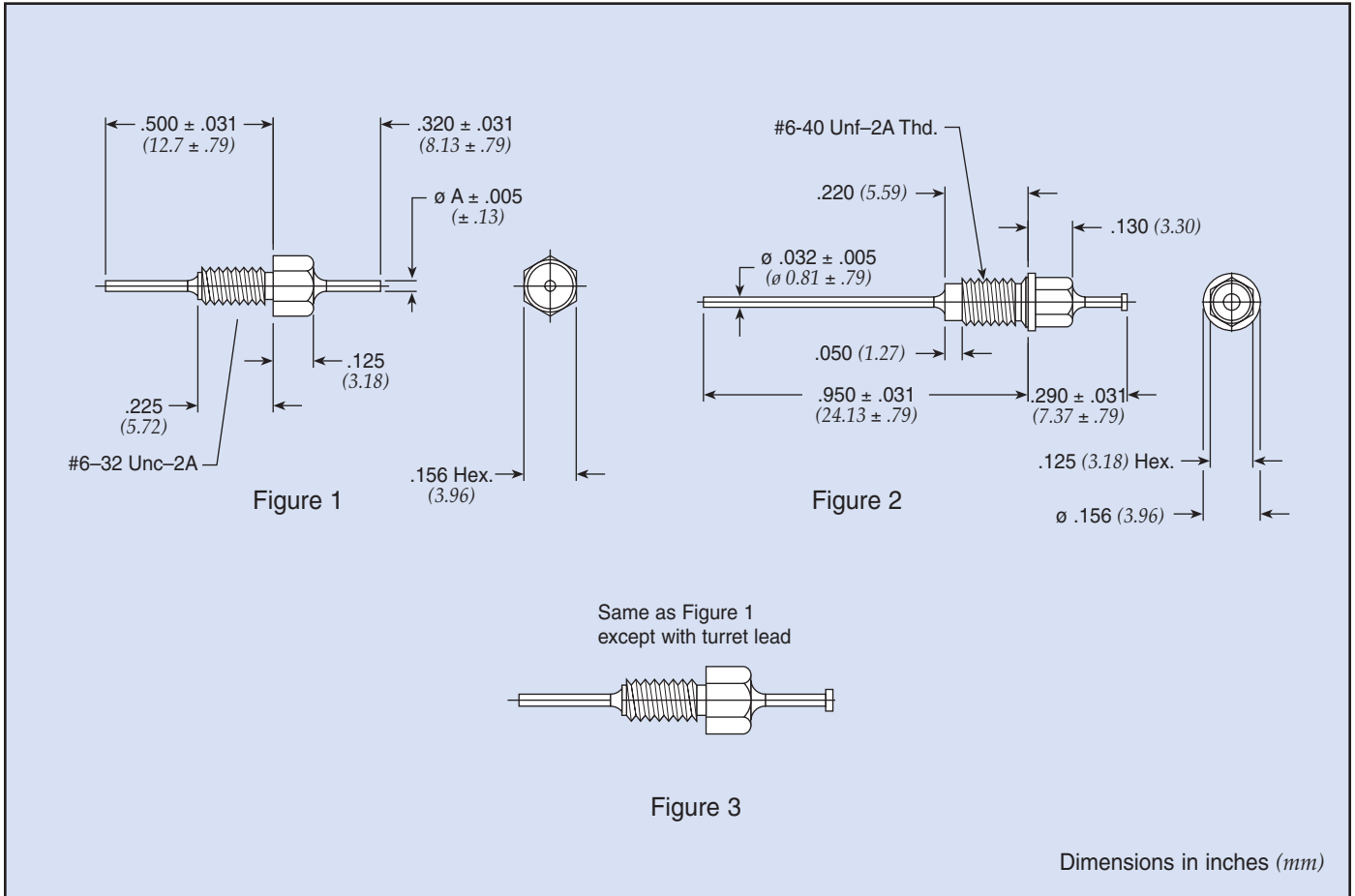

Part Number	Figure	Rated Voltage 125°C		I Amp	CKT	Min Cap	A		Minimum Insertion Loss (dB)							
		DC	AC				In	(mm)	1 MHz	3 MHz	10 MHz	30 MHz	100 MHz	300 MHz	1 GHz	10 GHz
† 51-726-008	1	50	—	3	Pi	5500 pF	0.018	(0.46)	—	7	14	30	55	70	70	70
51-726-017	1	50	—	3	Pi	9000 pF	0.018	(0.46)	—	8	18	45	65	70	70	70
54-779-019	1	50	—	10	C	0.10 µF	0.032	(0.81)	22	31	40	44	47	55	65	65
† 54779001X5F100M	1	100	—	10	C	10 pF ± 20%	0.032	(0.81)	—	—	—	—	—	—	10	10
† 54779001X5U102P €	1	100	—	10	C	1000 pF	0.032	(0.81)	—	—	—	10	21	28	28	28
54-779-014	1	100	—	10	C	2700 pF	0.032	(0.81)	—	—	9	18	27	33	35	35
54-779-016	1	100	—	10	C	0.01 µF	0.032	(0.81)	—	9	20	29	38	45	50	50
† 51-726-002	3	100	—	10	LB	0.022 µF	0.032	(0.81)	7	17	27	34	43	50	60	60
54-779-017	1	100	—	10	C	0.027 µF	0.032	(0.81)	10	20	30	37	45	50	55	60
54-779-018	1	100	—	10	C	0.050 µF	0.032	(0.81)	15	24	34	41	45	50	60	60
† 51-726-001	1	200	—	3	Pi	1500 pF	0.018	(0.46)	—	—	5	15	42	65	70	70
† 1289-001	2	200	—	10	Pi	1500 pF	0.032	(0.81)	—	—	5	15	40	60	60	60
† 1289-004	2	200	—	10	Pi	3000 pF	0.032	(0.81)	—	—	8	15	50	65	70	70
54-779-015	1	200	—	10	C	5600 pF	0.032	(0.81)	—	—	15	24	33	37	40	40

† Also available through Spectrum Control's authorized distributors.

€ Also available through Spectrum Control's authorized European distributors/agents.

Resin Sealed Bolt-in Filters

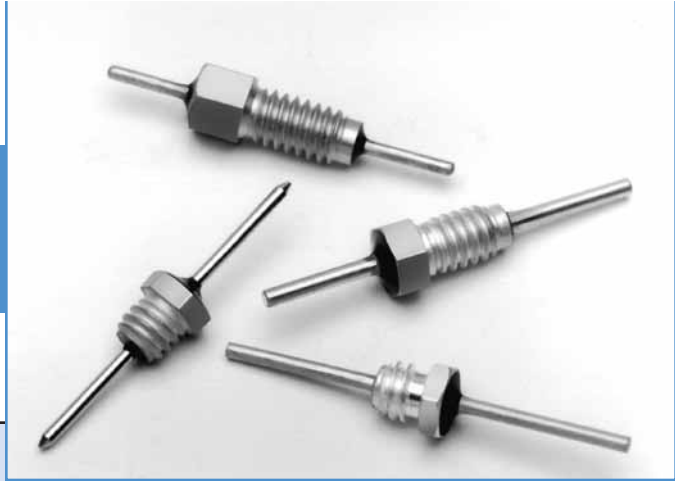

8-32 C Circuit

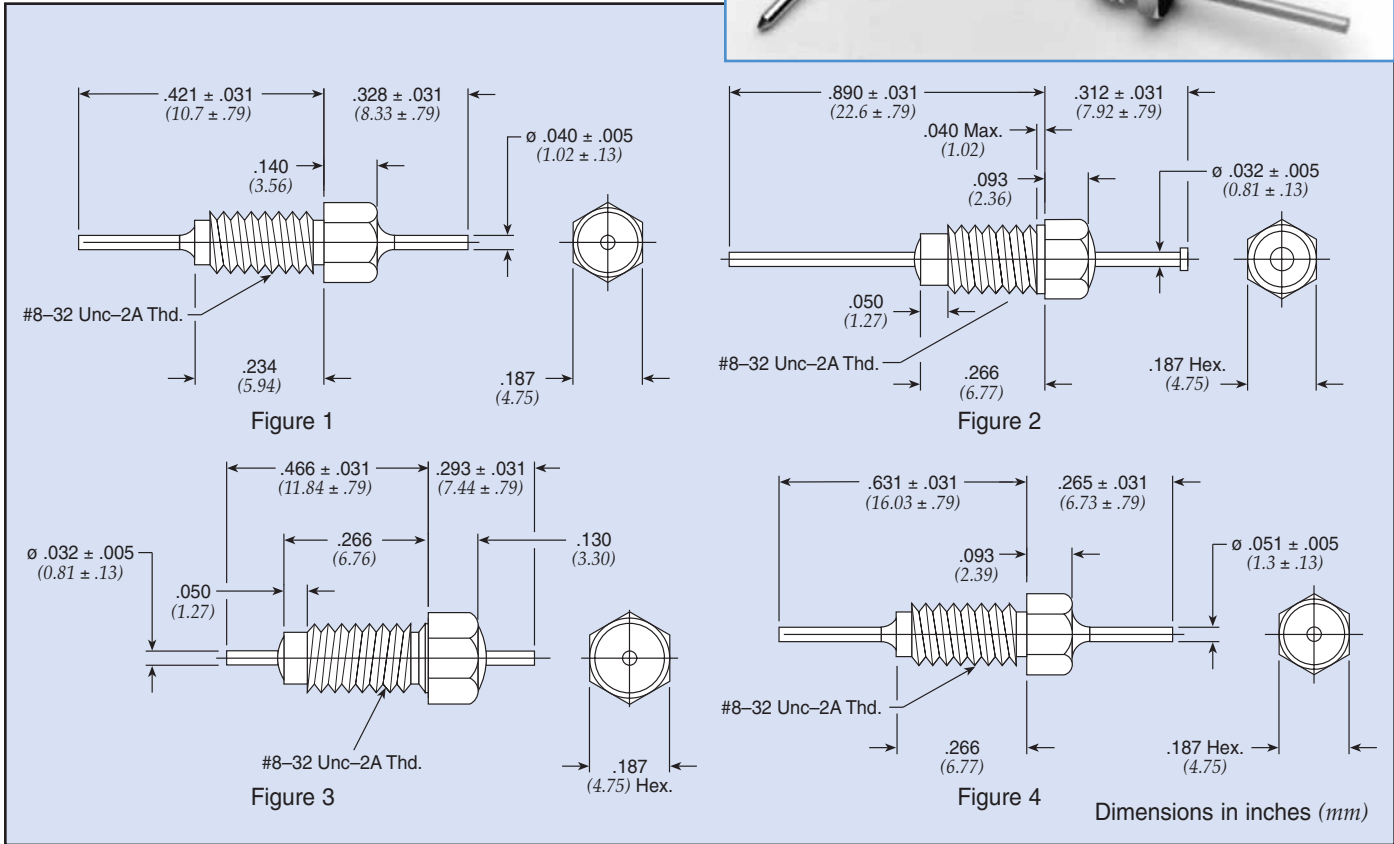

Low Pass Filters

Part Number	Figure	Rated Voltage 125°C		I Amp	Min Cap	Minimum Insertion Loss (dB)							
		DC	AC			1 MHz	3 MHz	10 MHz	30 MHz	100 MHz	300 MHz	1 GHz	10 GHz
SCI-9200-503	2	50	—	10	0.05 μ F	15	24	35	41	45	50	60	60
9950-381-6009	3	50	—	10	0.12 μ F	20	30	43	45	55	55	55	55
54-785-017	1	50	—	10	0.21 μ F	28	37	45	50	55	60	70	70
9950-381-6008	3	70	—	10	0.08 μ F	15	24	37	41	51	51	55	55
† 54713001X5F101M	4	100	—	10	80 pF	—	—	—	—	—	10	20	20
† 54713001X5U102P	4	100	—	10	1000 pF	—	—	—	11	20	28	28	28
54-785-013	1	100	—	10	0.01 μ F	—	9	20	29	38	45	50	55
SCI-9210-103	2	100	—	10	0.01 μ F	—	12	20	29	38	45	50	50
SCI-9210-273	2	100	—	10	0.027 μ F	10	20	30	36	45	50	55	60
† 54-785-005	1	100	—	10	0.05 μ F	15	24	34	41	45	50	60	60
54-785-016	1	100	—	10	0.1 μ F	20	29	38	44	47	55	65	65
54-785-011	1	150	—	10	2000 pF	—	—	8	17	26	32	34	35
54-785-012	1	150	—	10	5000 pF	—	6	15	24	33	37	40	40
SCI-9220-101	2	200	115	10	100 pF	—	—	—	—	—	10	20	25
SCI-9220-102	2	200	115	10	1000 pF	—	—	—	11	20	28	28	28
SCI-9220-502	2	200	115	10	5000 pF	—	6	15	24	33	37	40	40

† Also available through Spectrum Control's authorized distributors.

Resin Sealed Bolt-in Filters

8-32 L & Pi Circuit

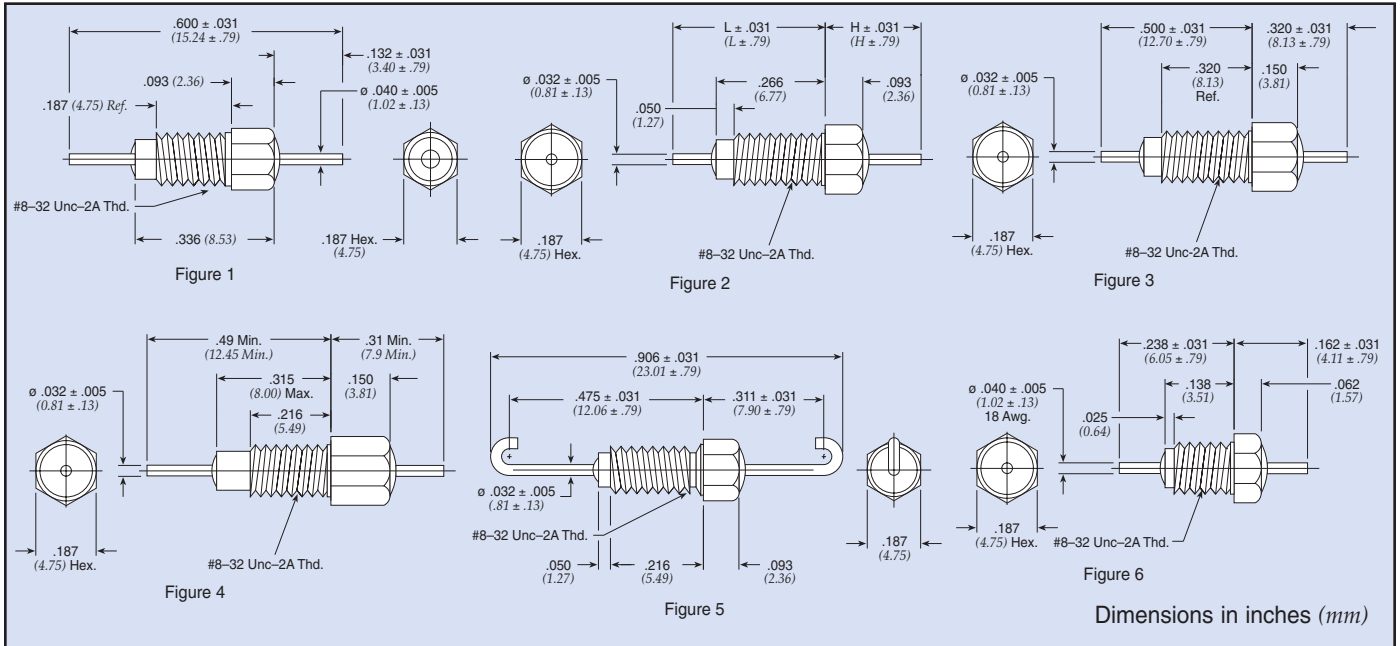

Low Pass Filters

Part Number	M15733 MIL Number	Fig.	Rated Voltage 125°C		I Amp	CKT	Min Cap	In	H (mm)	L In	L (mm)	Minimum Insertion Loss (dB)							
			DC	AC								1 MHz	3 MHz	10 MHz	30 MHz	100 MHz	300 MHz	1 GHz	10 GHz
51-712-069 €	—	2	50	—	10	Pi	0.012 μ F	0.265	(6.73)	0.413	(10.49)	5	9	18	45	65	70	70	70
+ 51-712-065	/61-0014	4	50	—	20	Pi	0.012 μ F	0.310	(7.87)	0.490	(12.45)	—	10	20	30	65	70	70	70
+ 1250-054	—	2	70	—	10	Pi	5000 pF	0.312	(7.92)	0.500	(12.70)	—	—	20	30	65	65	70	70
+ 1293-001	—	3	70	—	10	Pi	0.028 μ F	—	—	—	—	10	14	38	65	75	75	75	75
51-712-055	/43-0002	2	100	70	10	Pi	3000 pF	0.312	(7.92)	0.578	(14.68)	—	—	5	15	45	50	50	50
+ 51-712-014	/28-0001	2	100	70	10	Pi	3000 pF	0.312	(7.92)	0.890	(22.61)	—	—	5	15	45	60	60	60
51-712-028	/28-0002	5	100	70	10	Pi	3000 pF	—	—	—	—	—	—	5	15	45	60	60	60
+ 51-712-063*	/61-0008	2	100	70	10	Pi	5500 pF	0.312	(7.92)	0.500	(12.70)	—	—	15	35	65	70	70	70
+ 51-712-003 ◊	—	2	100	—	10	LB	0.022 μ F	0.280	(7.11)	0.850	(21.59)	7	17	27	34	43	50	60	60
51-712-060 ◊	/28-0004	2	100	70	10	LB	0.022 μ F	0.312	(7.92)	0.890	(22.61)	10	17	28	34	41	50	60	60
+ 51-712-067	/61-0013	2	100	—	10	LB	0.031 μ F	0.280	(7.11)	0.890	(22.61)	10	20	30	38	42	52	60	60
51-762-006	/44-0003	6	125	85	15	Pi	65 pF	—	—	—	—	—	—	—	—	—	—	16	42
+ 1250-059	—	6	125	—	15	Pi	1500 pF	—	—	—	—	—	—	5	15	35	45	60	60
+ 51-762-005	/44-0002	6	125	85	15	Pi	1500 pF	—	—	—	—	—	—	5	15	25	35	50	50
1250-062	—	1	125	—	15	Pi	3000 pF	—	—	—	—	—	—	5	15	45	45	70	70
+ 51-744-003*	/44-0001	1	125	85	15	Pi	3000 pF	—	—	—	—	—	—	10	15	30	40	65	65
+ SCI-3223-000	—	2	200	115	10	Pi	2000 pF	0.312	(7.92)	0.890	(22.61)	—	—	8	10	48	50	70	70
+ 1250-003 €	—	2	200	—	10	Pi	3000 pF	0.312	(7.92)	0.890	(22.61)	—	—	5	15	45	65	70	70
+ 51-712-001*	—	2	200	—	10	Pi	3000 pF	0.312	(7.92)	0.890	(22.61)	—	—	5	15	45	65	70	70
1250-049	—	2	200	—	10	Pi	3000 pF	0.312	(7.92)	0.578	(14.68)	—	—	5	15	45	65	65	60
+ 51-744-002 ◊	—	2	200	—	10	Pi	5500 pF	0.265	(6.73)	0.413	(10.49)	—	7	14	30	55	70	70	70
+ 1293-000	—	3	200	—	10	Pi	0.012 μ F	—	—	—	—	5	10	28	40	65	70	70	70

† Also available through Spectrum Control's authorized distributors.

◊ Supplied with .040" (1.02mm) diameter lead.

€ Also available through Spectrum Control's authorized European distributors/agents.

* Denotes parts with turret lead.

Resin Sealed Bolt-in Filters



10-32 C & Pi Circuit

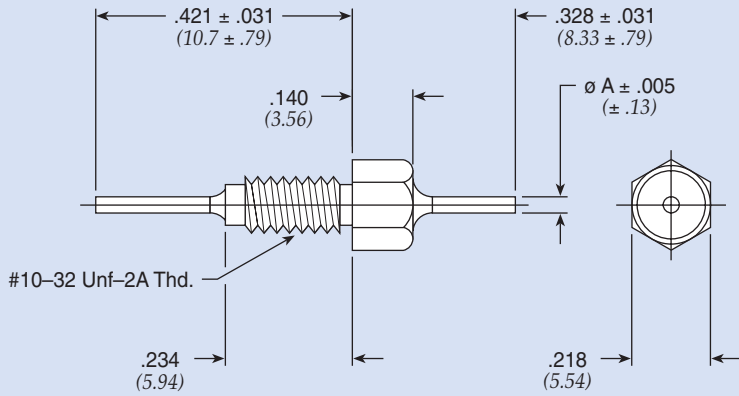

Figure 1

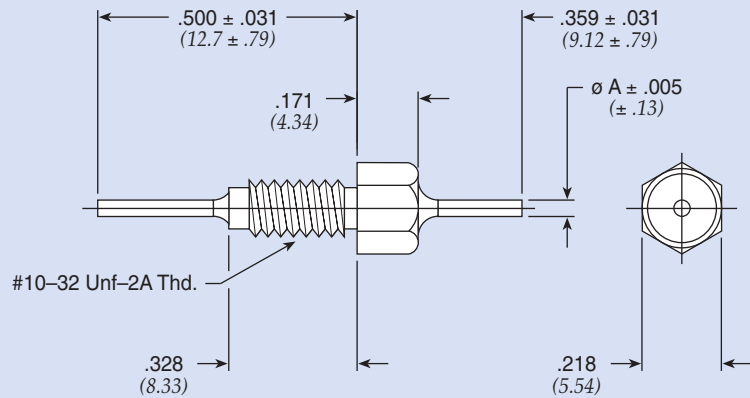

Figure 2

Dimensions in inches (mm)

Part Number	Figure	Rated Voltage 125°C		I Amp	CKT	Min Cap	A		Minimum Insertion Loss (dB)							
		DC	AC				In	(mm)	1 MHz	3 MHz	10 MHz	30 MHz	100 MHz	300 MHz	1 GHz	10 GHz
51-761-002	1	50	—	10	Pi	0.018 µF	0.032	(0.81)	7	14	30	55	70	70	70	70
† 54-786-013	1	50	—	10	C	0.3 µF	0.040	(1.02)	30	38	47	50	55	60	70	70
54-786-028	1	50	—	10	C	0.56 µF	0.040	(1.02)	35	43	50	52	60	65	70	70
† 54-786-014	2	50	—	10	C	0.8 µF	0.040	(1.02)	40	46	52	54	70	70	70	70
51-761-001	1	100	—	10	Pi	0.01 µF	0.032	(0.81)	—	10	20	45	65	70	70	70
54-786-027	1	200	—	10	C	0.1 µF	0.040	(1.02)	20	29	38	44	47	55	65	65

† Also available through Spectrum Control's authorized distributors.

Resin Sealed Bolt-in Filters

12-28 C /12-32 C Circuit

Low Pass Filters

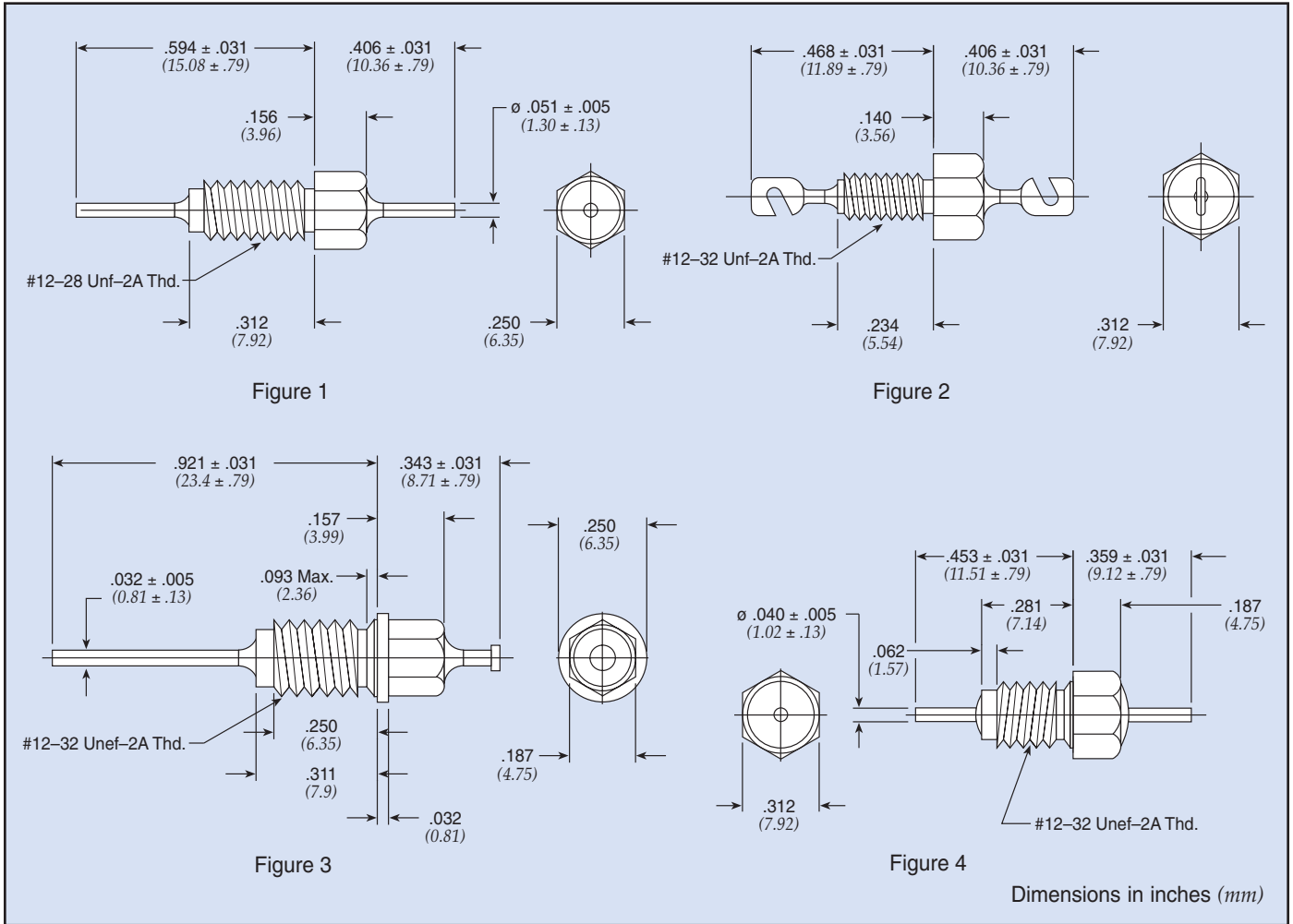

Part Number	Figure	Rated Voltage 125°C		I Amp	CKT	Min Cap	Minimum Insertion Loss (dB)							
		DC	AC				1 MHz	3 MHz	10 MHz	30 MHz	100 MHz	300 MHz	1 GHz	10 GHz
9910-381-6004	4	35	—	15	C	1 µF	38	40	52	52	70	70	78	80
9910-381-6003	4	50	—	15	C	0.75 µF	35	37	51	51	61	61	65	70
SCI-9310-273	3	100	—	10	C	0.027 µF	10	20	30	37	45	50	55	60
9910-381-6002	4	100	—	15	C	0.30 µF	28	30	45	50	55	55	60	65
54804002X5R101M	2	250	—	10	C	100 pF ± 20%	—	—	—	—	—	10	20	25
† 54804002X5R471M	2	250	—	10	C	470 pF ± 20%	—	—	—	—	12	22	25	28
† 54804002X5V102P	2	250	—	10	C	1000 pF	—	—	—	10	21	28	28	28
54743001X5U102Z	1	250	—	15	C	1000 pF	—	—	—	—	20	28	28	28

† Also available through Spectrum Control's authorized distributors.

Resin Sealed Bolt-in Filters



12-28 & 12-32 Pi Circuit

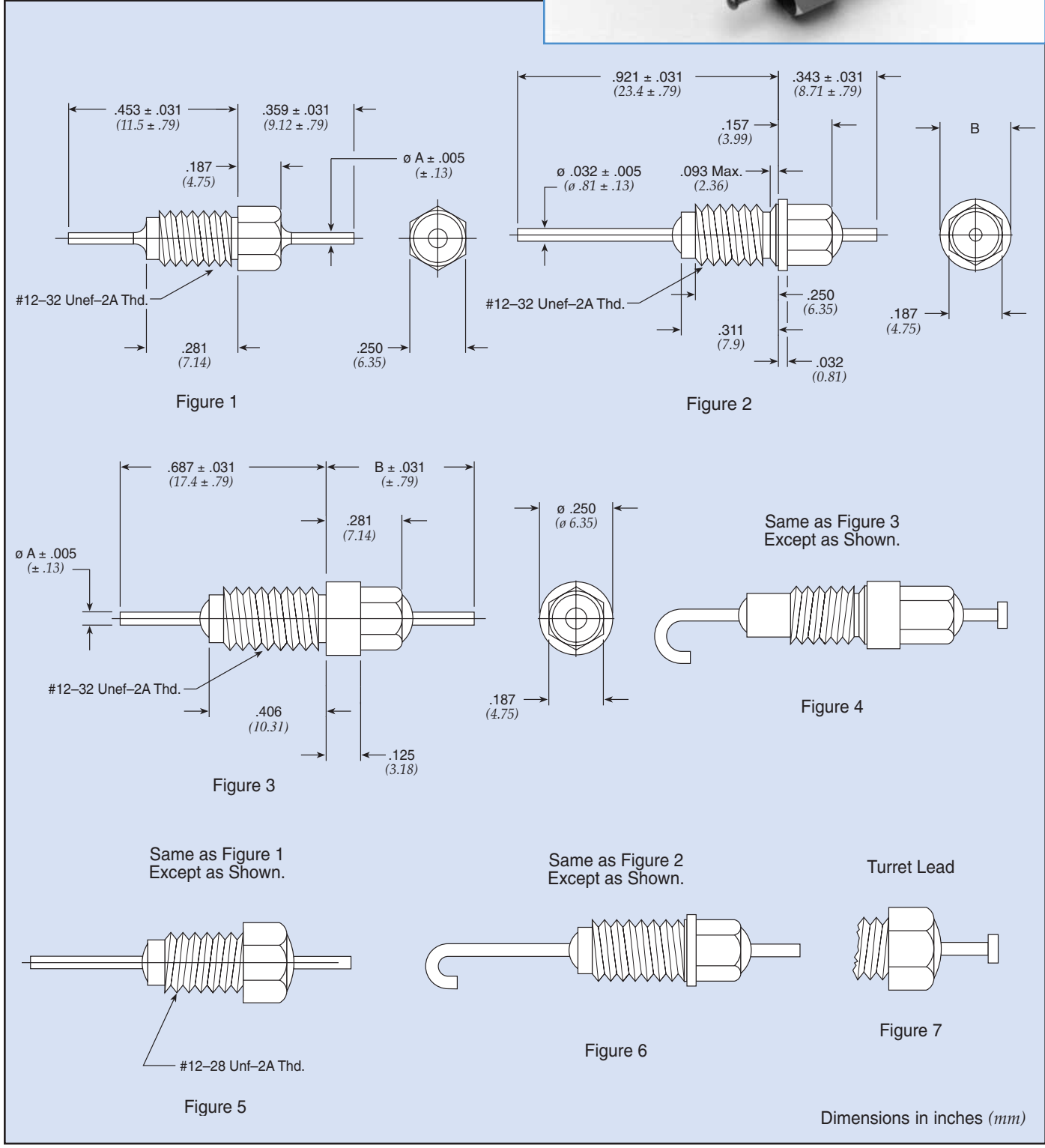

Low Pass Filters

Resin Sealed Bolt-in Filters

12-28 & 12-32 Pi Circuit

Low Pass Filters

Part Number	M15733 MIL Number	See Pg. 79 for Fig.	Rated Voltage 125°C		I Amp	Min Cap	A		B		Minimum Insertion Loss (dB)							
			DC	AC			In	(mm)	In	(mm)	1 MHz	3 MHz	10 MHz	30 MHz	100 MHz	300 MHz	1 GHz	10 GHz
51-709-013	—	3	50	—	10	0.1 µF	0.040	(1.02)	0.437	(11.10)	10	40	52	70	70	70	70	70
SCI-3303-000*	—	2	50	—	10	0.15 µF	0.032	(0.81)	0.250	(6.35)	12	43	68	70	70	70	70	70
51-709-015	/61-0009	3	70	—	10	0.012 µF	0.032	(0.81)	0.470	(11.94)	—	—	—	—	65	65	65	65
† 1216-001	—	3	70	—	10	0.050 µF	0.032	(0.81)	0.468	(11.89)	15	20	60	65	75	75	75	75
† 1270-016*	—	2	100	—	10	5500 pF	0.032	(0.81)	0.250	(6.35)	—	7	20	35	65	70	70	70
† 1270-025	—	2	100	—	10	5500 pF	0.032	(0.81)	0.235	(5.97)	—	7	20	35	65	70	70	70
† 1201-066	—	1	100	—	10	5500 pF	0.032	(0.81)	—	—	—	7	20	40	68	70	70	70
51-714-055*	/61-0011	2	100	—	10	5500 pF	0.032	(0.81)	0.235	(5.97)	—	7	20	—	65	70	70	70
51-714-054*	/61-0010	2	100	—	10	5500 pF	0.032	(0.81)	0.250	(6.35)	—	7	20	—	65	70	70	70
51-714-053*	/61-0007	2	100	70	10	5500 pF	0.032	(0.81)	0.250	(6.35)	—	7	—	—	65	70	70	70
51-714-058*	—	2	100	—	10	0.025 µF	0.032	(0.81)	0.250	(6.35)	10	15	40	60	70	70	70	70
51-714-056	/61-0012	6	100	—	10	0.025 µF	0.032	(0.81)	0.235	(5.97)	—	—	—	—	65	65	65	65
† SCI-3313-000*	—	2	100	—	10	0.10 µF	0.032	(0.81)	0.250	(6.35)	10	40	65	70	70	70	70	70
51-719-022	—	1	200	—	10	1300 pF	0.040	(1.02)	—	—	—	—	5	10	35	60	70	70
† 1201-052	—	5	200	—	10	3000 pF	0.032	(0.81)	—	—	—	—	5	15	45	45	70	70
† 1201-054	—	1	200	—	10	3000 pF	0.032	(0.81)	—	—	—	—	5	15	45	45	70	70
51-714-001*	—	2	200	—	10	3000 pF	0.032	(0.81)	0.250	(6.35)	—	—	5	15	43	60	70	70
† 1270-024	—	2	200	—	10	3000 pF	0.032	(0.81)	0.235	(5.97)	—	—	5	15	45	45	70	70
51-714-003*	—	2	200	—	10	3000 pF	0.032	(0.81)	0.235	(5.97)	—	—	5	15	43	60	70	70
† 1270-009	—	2	200	—	10	3000 pF	0.032	(0.81)	0.250	(6.35)	—	—	5	15	45	45	70	70
51-719-053**	/61-0001	5	200	140	10	3000 pF	0.032	(0.81)	—	—	—	—	—	—	45	—	70	70
51-719-054*	/61-0002	1	200	140	10	1500 pF	0.032	(0.81)	—	—	—	—	—	—	45	45	70	70
51-714-051*	/61-0005	2	200	140	10	1500 pF	0.032	(0.81)	0.250	(6.35)	—	—	—	—	45	45	70	70
51-719-023*	/43-0001	5	200	140	10	3000 pF	0.032	(0.81)	—	—	—	—	—	—	45	45	45	45
51-714-052*	/61-0006	2	200	140	10	3000 pF	0.032	(0.81)	0.235	(5.97)	—	—	—	—	45	45	70	70
51-714-004*	—	2	200	—	10	5500 pF	0.032	(0.81)	0.235	(5.97)	—	7	14	35	60	70	70	70
† 51-719-021	—	1	200	—	10	5500 pF	0.040	(1.02)	—	—	—	7	14	30	50	65	65	65
€ 51-714-002*	—	2	200	—	10	5500 pF	0.032	(0.81)	0.250	(6.35)	—	7	14	35	60	70	70	70
† SCI-3323-000*	—	2	200	115	10	0.012 µF	0.032	(0.81)	0.250	(6.35)	—	—	27	30	70	70	70	70
† 1221-001	—	4	300	—	10	5500 pF	0.032	(0.81)	0.437	(11.10)	—	—	15	30	65	70	70	70
† 51-709-004	/46-0001	4	300	—	10	5500 pF	0.032	(0.81)	0.437	(11.10)	—	—	—	—	65	70	70	70
1201-086	—	1	350	—	10	2500 pF	0.040	(1.02)	—	—	—	—	5	10	50	50	65	65
† 51-719-011 €	—	1	500	—	10	3000 pF	0.040	(1.02)	—	—	—	—	12	20	45	60	60	60

† Also available through Spectrum Control's authorized distributors.

€ Also available through Spectrum Control's authorized European distributors/agents.

* Denotes parts supplied with lead as shown in Figure 7.

** Bushing housing will have 1 1/2 imperfect threads at hex to thread interface.

Resin Sealed Bolt-in Filters

5/16-24 & 5/16-32 C & Pi Circuit

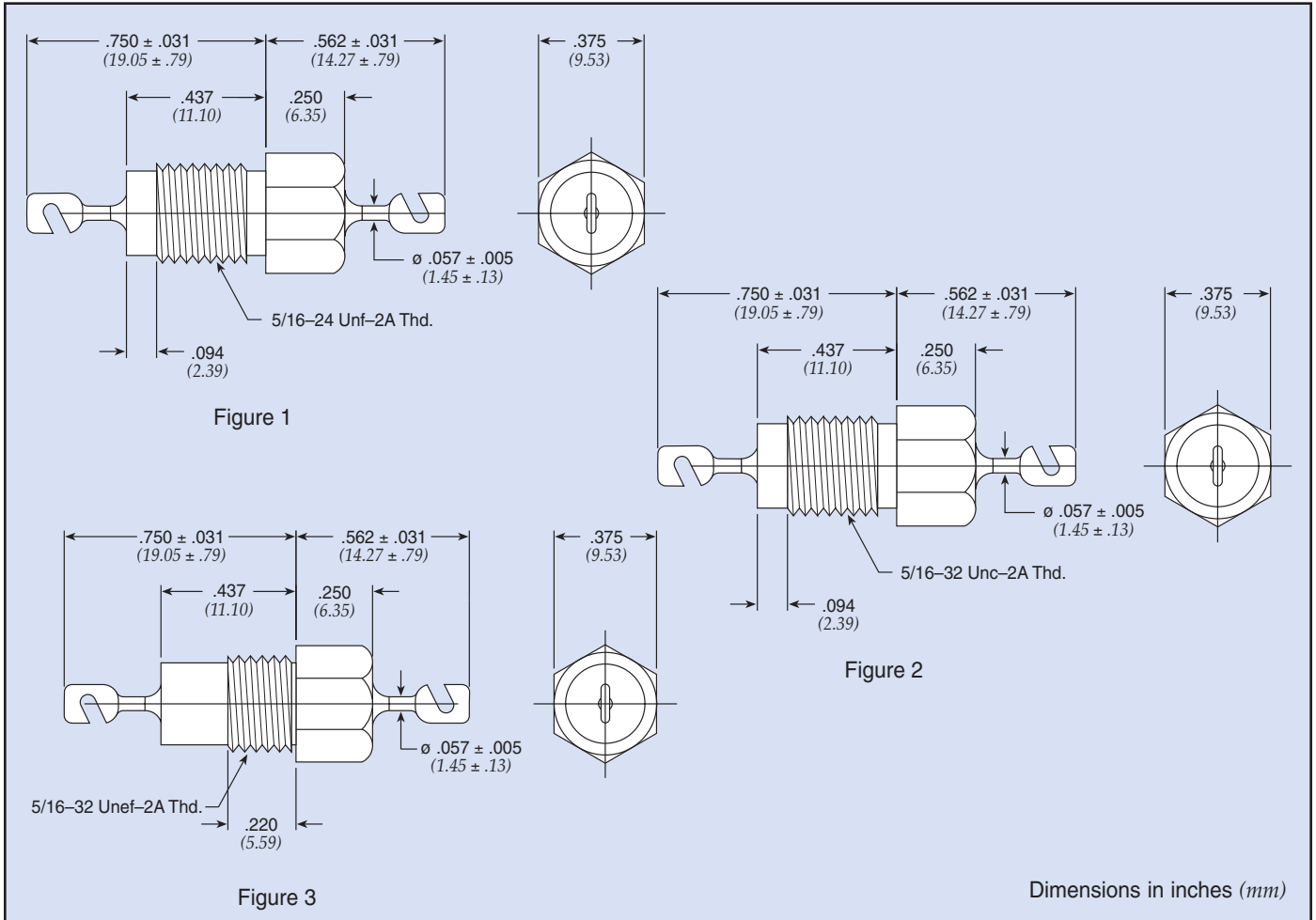

Part Number	M15733 MIL Number	Fig.	Rated Voltage 125°C		I Amp	CKT	Min Cap	Minimum Insertion Loss (dB)							
			DC	AC				1 MHz	3 MHz	10 MHz	30 MHz	100 MHz	300 MHz	1 GHz	10 GHz
SCI-9510-503	—	1	100	—	25	C	0.05 µF	15	24	35	41	45	60	60	60
SCI-3513-000	—	1	100	—	25	Pi	0.1 µF	10	18	28	37	70	70	70	70
SCI-3523-000	—	1	200	115	25	Pi	0.02 µF	—	—	25	50	66	66	70	70
SCI-3543-000	—	1	400	220	25	Pi	6000 pF	—	—	15	35	54	65	70	70
SCI-9550-102	—	1	500	115	25	C	1000 pF	—	—	—	11	20	28	28	28
† 1202-052	—	1	500	—	25	Pi	3000 pF	—	—	10	35	55	55	70	70
† 1202-054	—	2	500	—	25	Pi	3000 pF	—	—	10	35	55	55	70	70
51-702-020*	/61-0003	3	500	350	25	Pi	3000 pF	—	—	—	35	55	55	70	70
51-702-021	/61-0004	3	500	350	25	Pi	3000 pF	—	—	10	35	55	55	70	70
SCI-9550-332	—	1	500	115	25	C	3300 pF	—	—	12	20	30	33	40	40
SCI-3553-000	—	1	500	220	25	Pi	0.012 µF	—	—	18	28	52	52	70	70
† 1202-005	—	2	700	—	25	Pi	2000 pF	—	—	5	20	50	55	70	70

† Also available through Spectrum Control's authorized distributors.

* Denotes parts with 5/16-24 Threads

High Current/High Voltage Resin Sealed Filters

High current filters are ideal for use in high current 5 volt logic buss, but also can be used for ± 48 VDC telephone rack buss, high current switch mode power supplies and DC charging systems. High voltage filters find use in high voltage power supplies and applications requiring U.L. Hi-Pot.

Features

- Current ratings up to 100 Amps
- Continuous voltage ratings up to 1250 VDC/240 VAC (400Hz)
- U.L. 1459 recognized and CSA C22.2 approved versions available
- Rugged bolt-in style for easy installation



Installation Notes

for Figure 1 & 2 — see below (Figure 3 see page 16)

1. Mounting installation torque
 - Method A:** Mounting in full threaded thru hole
Maximum torque: 96 in-lbs
 - Method B:** Mounting w/hardware
Maximum torque: 84 in-lbs
 2. Terminal installation torque
Maximum torque: 20 in-lbs
- Note: Use two wrench method to install terminal hardware

Low Pass Filters

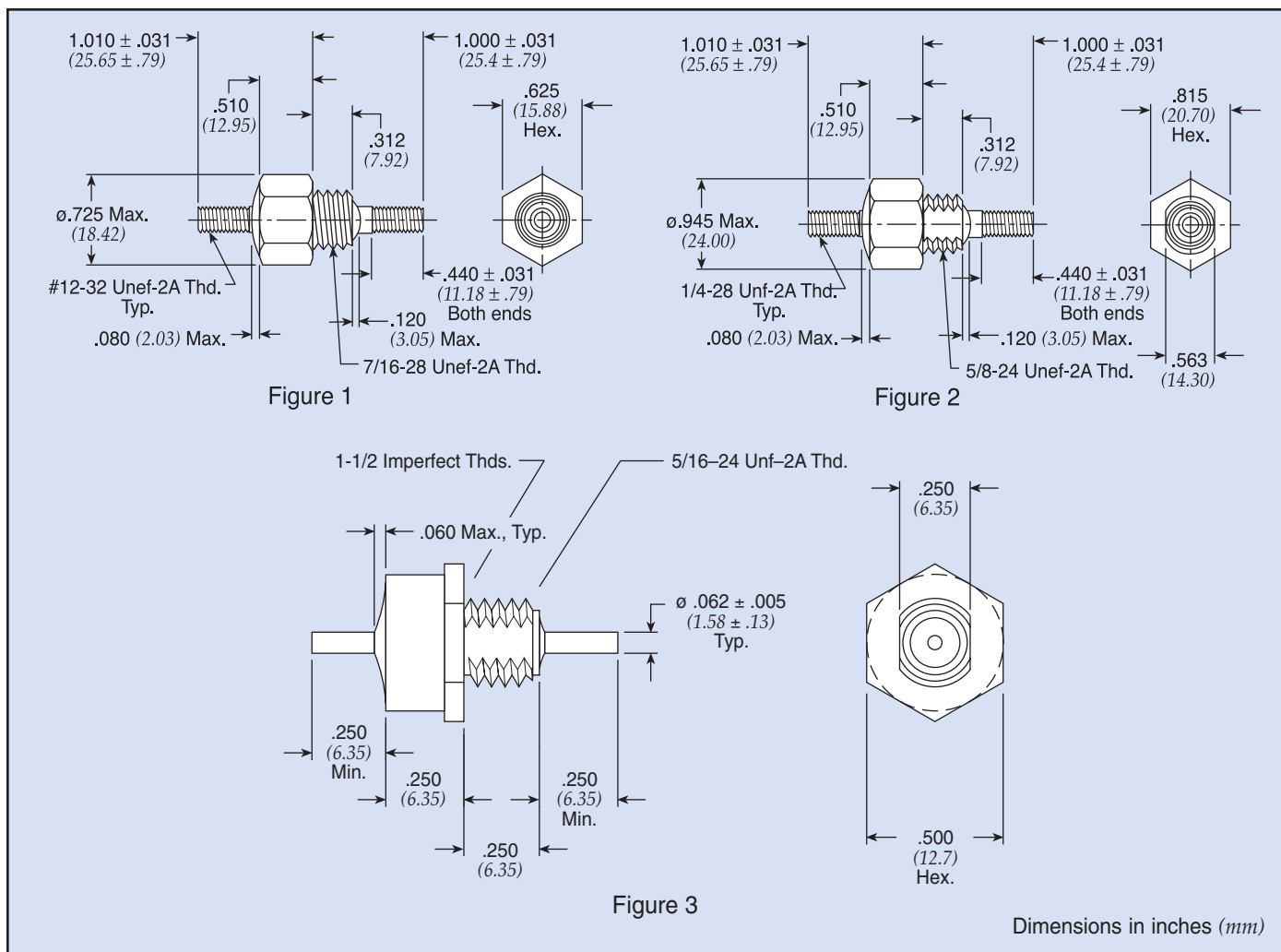

High Current/High Voltage Resin Sealed Filters

High Current High Voltage Feed-thru

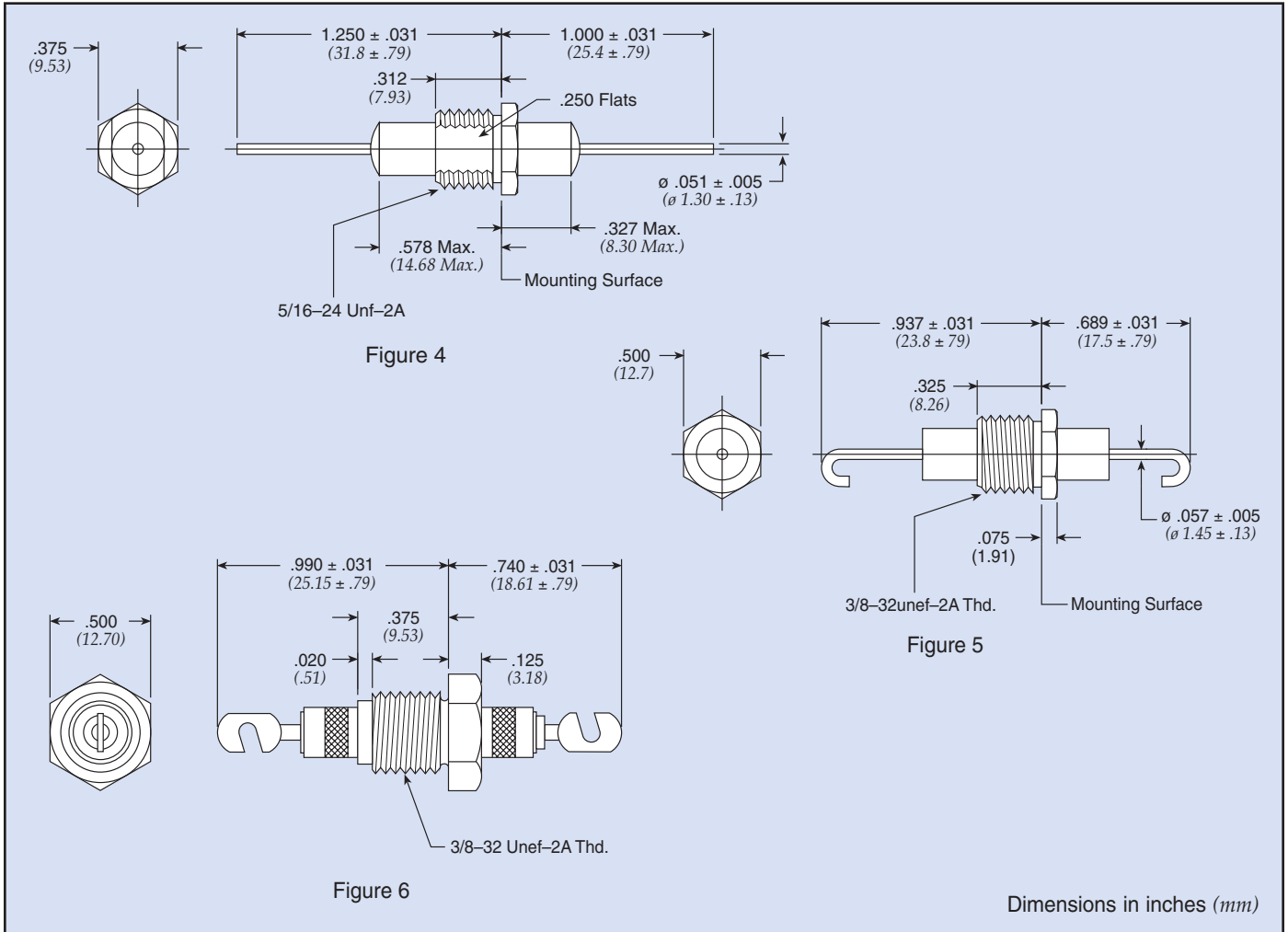

Part Number	Figure	Rated Voltage 125°C		I Amp	CKT	Min Cap	Minimum Insertion Loss (dB)							
		DC	AC***				1 MHz	3 MHz	10 MHz	30 MHz	100 MHz	300 MHz	1 GHz	10 GHz
54-848-005*	1	60	—	50	C	0.22 μ F	20	30	40	50	50	50	50	50
54-853-001*	2	60	—	50	C	0.22 μ F	20	30	40	50	50	50	50	50
54-853-004 €	2	200	140	100	C	0.22 μ F	20	30	40	50	50	50	50	50
54-848-008	1	200	140	100	C	0.22 μ F	20	30	40	50	50	50	50	50
54-844-001**	3	600	240	25	C	4700 pF \pm 20%	—	—	12	20	30	33	50	50
54-844-002**	3	600	240	25	C	0.01 μ F \pm 20%	3	7	20	25	35	40	57	57
54-763-008	4	750	—	25	C	1000 pF	—	—	—	10	20	28	28	28
54-763-009	4	750	—	25	C	4000 pF	—	—	10	22	32	35	35	40
54-789-003	5	1250	—	25	C	4000 pF	—	—	6	20	30	35	35	35
† 1280-060 €	6	2500	—	25	Pi	1500 pF	—	—	5	15	50	50	50	50

† Also available through Spectrum Control's authorized distributors.

€ Also available through Spectrum Control's authorized European distributors/agents.

* Denotes parts that are UL recognized to UL 60950 and certified to CSA C22.2

** Denotes parts that meet 1500 VAC Dielectric Withstanding Voltage per UL 1283 and CSA C22.2

*** AC Voltage to be 400Hz

Hermetically Sealed Threaded Case Filters

This series of filters features hermetic glass seals and high EMI filtering performance. They are excellent for critical applications that demand high reliability in the toughest environmental conditions and provide broadband high performance EMI filtering from 10 KHz to over 10 GHz.

Features

- Popular .375", .410" and .690" case diameters
- Voltage ratings from 50 VDC to 400 VDC/240 VAC, 400 Hz
- Filter configurations available: C, L, Pi, T and double T
- MIL-F-15733 and MIL-F-28861 QPL filters available



Low Pass Filters

Thread length: A - 0.187 (4.76) B - 0.312 (7.92)

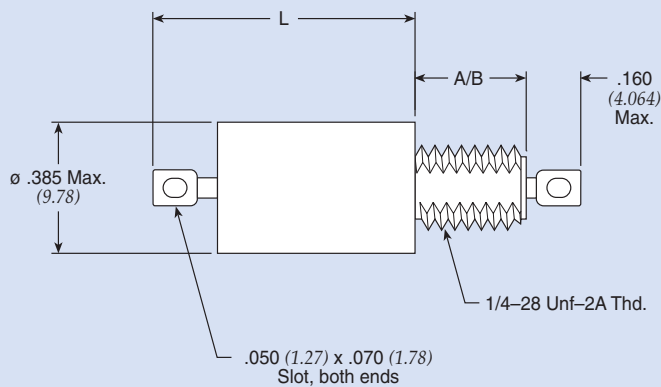

Figure 1

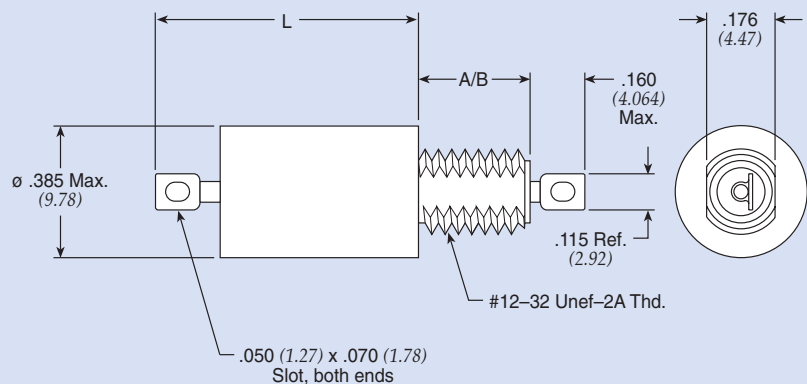

Figure 2

Dimensions in inches (mm)

Note: ø .410 Max. for M28861 parts

Hermetically Sealed Threaded Case Filters

.375 ø C Circuit Standard

Part Number	MIL No	See Pg. 84 for Fig.	Rated Voltage				I Amp	Min Cap µF	DCR Max Ohms	Max L		Thd Lgth	Minimum Insertion Loss (dB)						
			85°C		125°C					In	(mm)		30 KHz	150 KHz	300 KHz	1 MHz	10 MHz	100 MHz	1 GHz
			DC	AC	DC	AC													
† 54-367-008	—	1	80	—	50	—	15	1.400	0.005	0.387	(9.830)	A	15	28	33	44	60	70	70
54-370-007	—	1	80	—	50	—	15	2.800	0.005	0.576	(14.630)	A	20	34	39	50	60	70	70
54-371-001	—	1	80	—	50	—	15	4.000	0.005	0.688	(17.475)	A	26	40	46	55	60	70	70
54-367-005	—	1	150	—	100	—	15	0.450	0.005	0.387	(9.830)	A	6	19	25	36	55	70	70
† 9920-100-6002	—	1	200	—	150	125	15	0.150	0.005	0.387	(9.830)	A	—	6	15	26	42	55	70
54-367-007	—	1	250	—	200	125	15	0.015	0.005	0.387	(9.830)	A	—	—	—	6	25	45	50
† 54-367-006	—	1	250	—	200	125	15	0.250	0.005	0.387	(9.830)	A	—	14	19	30	50	65	70
54-370-006	—	1	250	—	200	125	15	0.500	0.005	0.630	(16.002)	A	7	20	28	39	55	70	70
9923-100-6004	—	1	400	—	400	240	15	0.060	0.005	0.415	(10.541)	A	—	5	10	18	38	55	70

.375 ø C Circuit MIL Qualified (See MIL index on page 244-246 for complete MIL part number listing)

Part Number	M15733 M28861 MIL No	See Pg. 84 for Fig.	Rated Voltage				I Amp	Min Cap µF	DCR Max Ohms	Max L		Thd Lgth	Minimum Insertion Loss (dB)						
			85°C		125°C					In	(mm)		30 KHz	150 KHz	300 KHz	1 MHz	10 MHz	100 MHz	1 GHz
			DC	AC	DC	AC													
54-367-054	1-012	1	—	—	50	—	15	1.200	0.008	0.410	(10.414)	B	15	28	33	40	40	70	70
54-367-049	1-002	1	—	—	50	—	15	1.200	0.008	0.410	(10.414)	A	15	28	33	40	40	70	70
54-370-032	49-0008	1	—	—	50	—	15	2.100	0.010	0.576	(14.630)	A	20	33	40	50	65	70	70
54-367-055	1-014	1	—	—	70	—	15	0.700	0.008	0.410	(10.414)	B	10	24	30	40	40	64	70
54-370-030	34-0035	2	—	—	100	—	10	0.300	0.004	0.474	(12.040)	A	7	19	25	35	55	70	70
54-367-051	1-006	1	—	—	100	—	15	0.450	0.008	0.410	(10.414)	A	6	19	25	36	40	60	70
54-367-056	1-016	1	—	—	100	—	15	0.450	0.008	0.410	(10.414)	B	6	19	25	36	40	60	70
54-367-057	1-018	1	—	—	150	—	15	0.250	0.008	0.410	(10.414)	B	—	14	20	31	40	56	70
54-367-053	1-010	1	—	—	200	125	15	0.150	0.008	0.410	(10.414)	A	—	10	16	26	40	52	70
54-367-058	1-020	1	—	—	200	125	15	0.150	0.008	0.410	(10.414)	B	—	10	16	26	40	52	70
54-370-034	49-0010	1	—	—	330	—	15	0.062	0.004	0.680	(17.272)	A	—	2	7	17	37	55	70

† Also available through Spectrum Control's authorized distributors.

Hermetically Sealed Threaded Case Filters

L-C Filter LT

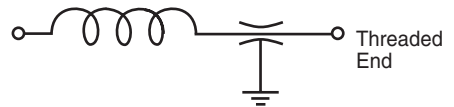

L-C Filter LB

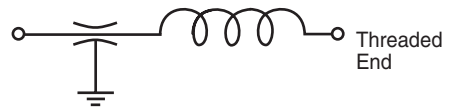

.375 ø L Circuit

Thread length: A - 0.187 (4.76) B - 0.312 (7.92)

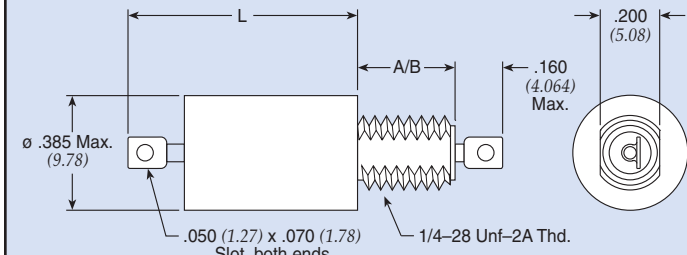

Figure 1

Note: ø .410 Max. for M28861 parts

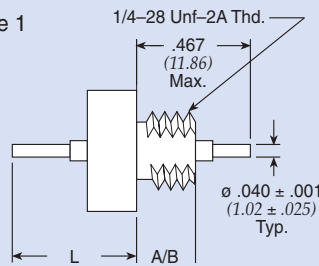

Figure 3

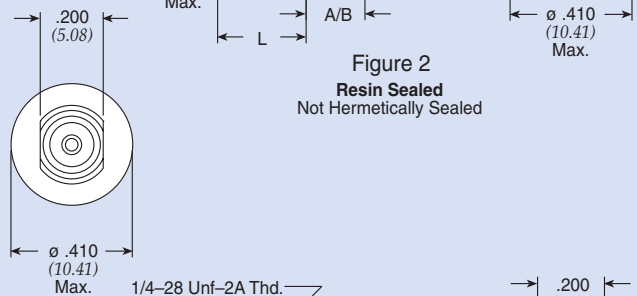

Figure 2
Resin Sealed
Not Hermetically Sealed

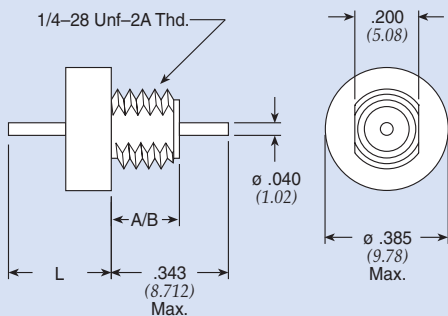

Figure 4

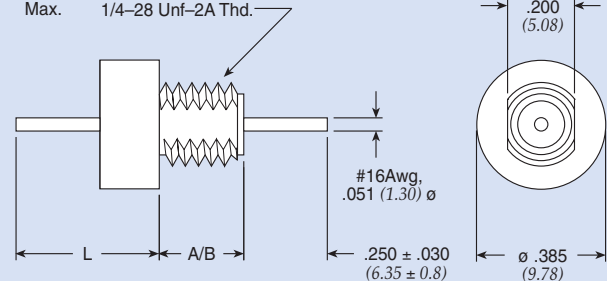

Figure 5

Dimensions in inches (mm)

.375 ø L Standard Low Profile

Part Number	MIL No	Figure	Rated Voltage				I Amp	Min Cap µF	DCR Max Ohms	CKT	Max L In	Max L (mm)	Thd Lgth	Minimum Insertion Loss (dB)						
			DC	AC	DC	AC								30 KHz	150 KHz	300 KHz	1 MHz	10 MHz	100 MHz	1 GHz
† 9051-100-0000	—	1	80	—	50	—	15	1.200	0.005	LB	0.370	(9.398)	A	15	25	34	44	60	70	70
† 51-359-001 €	—	1	80	—	50	—	15	1.400	0.005	LB	0.370	(9.398)	A	15	28	33	44	60	70	70
SCI-1021-000	—	2*	80	—	50	—	15	1.400	0.003	LB	0.280	(7.112)	A	15	28	33	44	60	70	70
† 9053-100-0001	—	1	80	—	50	—	15	1.400	0.005	LB	0.370	(9.398)	A	15	25	34	44	60	70	70
† 51-717-001 €	—	2*	80	—	50	—	15	1.400	0.005	LB	0.325	(8.255)	A	15	28	33	44	60	70	70
51-344-006	—	4	80	—	50	—	15	1.400	0.005	LB	0.330	(8.382)	A	15	28	33	44	60	70	70
† SCI-1020-000	—	1	80	—	50	—	15	1.400	0.003	LB	0.370	(9.398)	A	15	28	33	44	60	70	70
SCI-1021-020	—	2 ⁰ *	80	—	50	—	15	1.400	0.003	LB	0.280	(7.112)	B	15	28	33	44	60	70	70
† SCI-1020-020	—	1	80	—	50	—	15	1.400	0.003	LB	0.370	(9.398)	B	15	28	33	44	60	70	70
SCI-1150-001	—	1	80	—	50	—	15	2.800	0.003	LB	0.450	(11.430)	B	20	34	40	49	60	70	70
9051-101-0018	—	5	80	—	50	—	25	1.400	0.001	LB	0.450	(11.430)	A	15	25	34	44	60	70	70
† 9053-100-0008	—	1	100	—	70	—	15	0.700	0.005	LB	0.370	(9.398)	A	9	20	29	39	52	70	70

* Part is resin sealed, this is not a hermetic part.

† Also available through Spectrum Control's authorized distributors.

€ Also available through Spectrum Control's authorized European distributors/agents.

◇ Note: 0.462" (11.73mm) length from mounting surface to end of lead — not 0.347" (8.8mm).

Hermetically Sealed Threaded Case Filters

L-C Filter LT

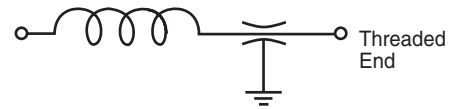

L-C Filter LB

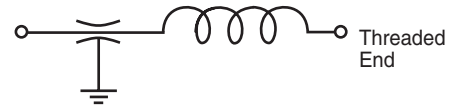

.375 ø L Standard Low Profile *continued*

Part Number	MIL No	See Pg. 86 for Fig	Rated Voltage				I Amp	Min Cap µF	DCR Max Ohms	CKT	Max L		Thd Lgth	Minimum Insertion Loss (dB)						
			85°C		125°C						In	(mm)		30 KHz	150 KHz	300 KHz	1 MHz	10 MHz	100 MHz	1 GHz
			DC	AC	DC	AC														
†9050-100-0008	—	2*	100	—	70	—	15	0.750	0.005	LB	0.325	(8.255)	A	9	20	29	39	52	70	70
†9053-100-0002	—	1	150	—	100	—	15	0.500	0.005	LB	0.370	(9.398)	A	4	12	21	31	48	70	70
SCI-1250-001	—	1	150	—	100	—	15	0.500	0.003	LB	0.450	(11.430)	B	8	20	25	34	50	64	70
€SCI-2150-000	—	1	150	—	100	—	15	1.000	0.003	LB	0.450	(11.430)	A	10	25	30	41	56	70	70
SCI-2150-001	—	1	150	—	100	—	15	1.000	0.003	LB	0.450	(11.430)	B	10	25	30	41	56	70	70
†51-717-007	—	2*	250	125	200	125	15	0.015	0.005	LB	0.325	(8.255)	A	—	—	—	6	25	38	45
†51-359-007	—	1	250	125	200	125	15	0.015	0.005	LB	0.370	(9.398)	A	—	—	—	6	25	38	50
9050-100-0011	—	2	350	125	300	125	15	0.150	0.008	LB	0.325	(8.255)	A	—	10	15	25	40	52	60
€SCI-2350-000	—	1	300	125	300	125	15	0.250	0.003	LB	0.450	(11.430)	A	4	15	21	31	50	70	70
SCI-2350-001	—	1	300	125	300	125	15	0.250	0.003	LB	0.450	(11.430)	B	4	15	21	31	50	70	70

* Part is resin sealed, this is not a hermetic part.

.375 ø L Circuit MIL Qualified Low Profile

(See MIL index on page 244-246 for complete MIL part number listing)

Part Number	M15733 M28861 MIL No	See Pg. 86 for Fig	Rated Voltage				I Amp	Min Cap µF	DCR Max Ohms	CKT	Max L		Thd Lgth	Minimum Insertion Loss (dB)						
			85°C		125°C						In	(mm)		30 KHz	150 KHz	300 KHz	1 MHz	10 MHz	100 MHz	1 GHz
			DC	AC	DC	AC														
†51-359-021	38-0004	1	—	—	50	—	10	1.400	0.008	LB	0.370	(9.398)	A	15	28	33	44	60	70	70
†51-359-024	38-0005	1	80	—	50	—	10	1.400	0.008	LB	0.370	(9.398)	A	15	28	33	44	60	70	70
†51-359-051	58-0001	1	80	—	50	—	10	1.400	0.008	LB	0.545	(13.843)	A	15	28	33	44	60	70	70
51-359-105	58-0004	1	80	—	50	—	10	1.400	0.008	LT	0.545	(13.843)	B	15	28	33	44	60	70	70
†51-359-044	49-0006	1	100	—	50	—	15	1.200	0.010	LB	0.370	(9.398)	A	15	28	33	44	60	70	70
†51-359-055	49-0007	3	100	—	50	—	15	1.200	0.010	LB	0.450	(11.43)	A	15	28	33	44	60	70	70
51-359-081	1-001	1	—	—	50	—	15	1.400	0.008	LB	0.410	(10.414)	A	15	28	33	40	40	70	70
51-359-086	1-011	1	—	—	50	—	15	1.400	0.008	LB	0.410	(10.414)	B	15	28	33	40	40	70	70
†51-359-053	49-0001	4	100	—	50	—	15	0.680	0.010	LB	0.319	(8.103)	A	8	20	28	38	55	70	70
51-359-082	1-003	1	—	—	70	—	15	0.700	0.008	LB	0.410	(10.414)	A	10	24	30	40	40	64	70
51-359-083	1-005	1	—	—	100	—	15	0.450	0.008	LB	0.410	(10.414)	A	6	19	25	36	40	60	70
51-359-088	1-015	1	—	—	100	—	15	0.450	0.008	LB	0.410	(10.414)	B	6	19	25	36	40	60	70
51-359-084	1-007	1	—	—	150	—	15	0.250	0.008	LB	0.410	(10.414)	A	—	14	20	31	40	56	70
51-359-050	38-0008	1	—	—	200	125	15	0.030	0.008	LB	0.370	(9.398)	A	—	—	—	6	25	42	60
51-359-085	1-009	1	—	—	200	125	15	0.150	0.008	LB	0.410	(10.414)	A	—	10	16	26	40	52	70
51-359-090	1-019	1	—	—	200	125	15	0.150	0.008	LB	0.410	(10.414)	B	—	10	16	26	40	52	70

† Also available through Spectrum Control's authorized distributors.

€ Also available through Spectrum Control's authorized European distributors/agents.

Hermetically Sealed Threaded Case Filters

.375 ø L Circuit

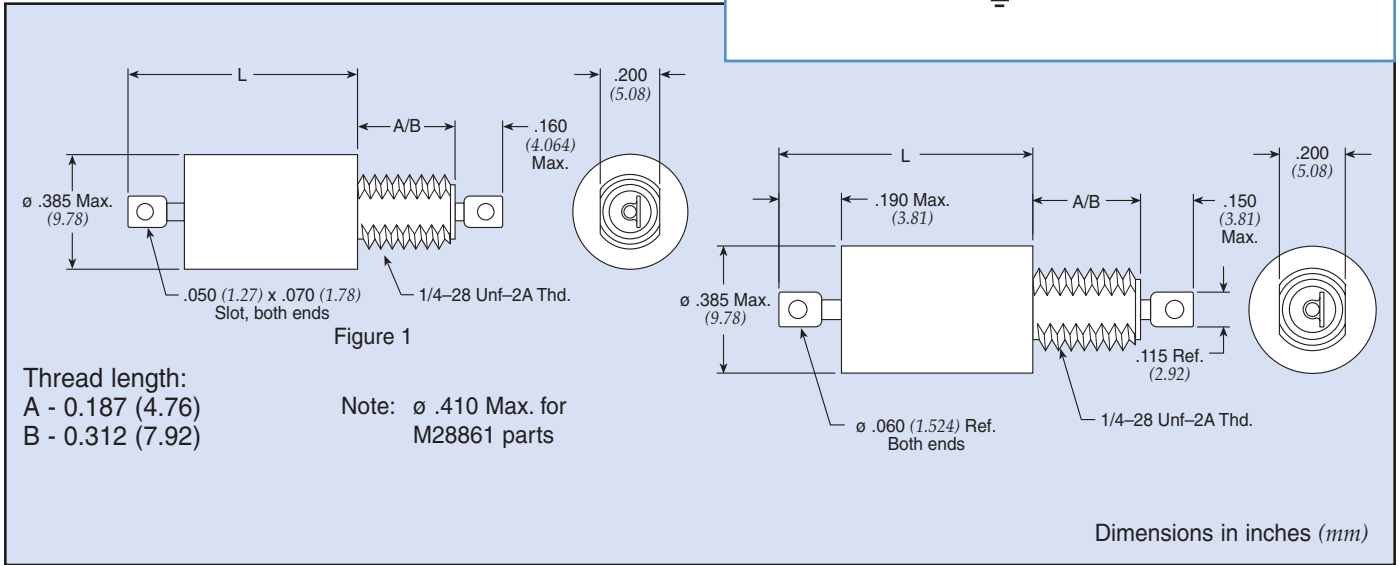

L-C Filter LT

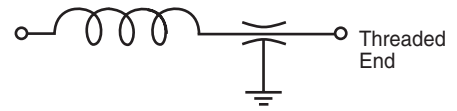

L-C Filter LB

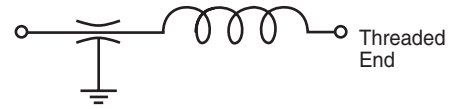

.375 ø L Circuit Standard Product

Part Number	MIL No	Figure	Rated Voltage				I Amp	Min Cap µF	DCR Max Ohms	CKT	Max L In	L (mm)	Thd Lgth	Minimum Insertion Loss (dB)						
			85°C DC	85°C AC	125°C DC	125°C AC								30 KHz	150 KHz	300 KHz	1 MHz	10 MHz	100 MHz	1 GHz
51-353-007	—	1	80	—	50	—	0.06	1.400	70.000	LB	0.770	(19.558)	A	44	70	70	70	70	70	70
51-353-095	—	1	80	—	50	—	0.15	1.400	12.000	LT	0.960	(24.384)	A	21	52	64	70	70	70	70
51-353-003	—	1	80	—	50	—	0.45	1.400	1.200	LB	0.770	(19.558)	A	16	31	37	55	70	70	70
51-353-099	—	1	80	—	50	—	1.00	1.400	0.250	LT	0.770	(19.558)	A	16	33	44	70	70	70	70
51-353-100	—	1	80	—	50	—	5.00	1.400	0.015	LT	0.770	(19.558)	A	15	28	33	46	70	70	70
†9200-300-0025	—	1	80	—	50	—	10.00	1.200	0.010	LB	0.450	(11.430)	A	15	28	33	44	60	70	70

† Also available through Spectrum Control's authorized distributors.

Hermetically Sealed Threaded Case Filters

L-C Filter LT

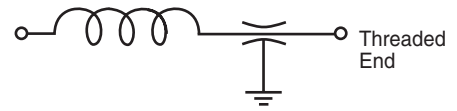

L-C Filter LB

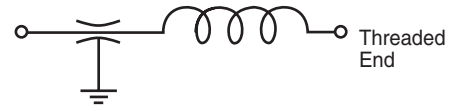

.375 ø L Circuit Standard Product *continued*

Part Number	MIL No	See Pg. 88 for Fig	Rated Voltage				I Amp	Min Cap µF	DCR Max Ohms	CKT	Max L		Thd Lgth	Minimum Insertion Loss (dB)						
			85°C		125°C						In	(mm)		30 KHz	150 KHz	300 KHz	1 MHz	10 MHz	100 MHz	1 GHz
			DC	AC	DC	AC														
†9200-303-0095	—	1	80	—	50	—	10.00	1.200	0.010	LB	0.450	(11.430)	B	15	28	33	44	60	70	70
51-353-101	—	1	80	—	50	—	10.00	1.400	0.010	LT	0.450	(11.430)	A	14	28	33	44	60	70	70
51-353-109	—	1	80	—	50	—	10.00	1.400	0.010	LT	0.450	(11.430)	B	15	28	33	44	60	70	70
51-353-120	—	1	150	—	100	—	1.00	0.750	0.250	LB	0.758	(19.253)	A	9	27	36	57	70	70	70
9000-103-0019	—	1	150	—	100	—	5.00	0.450	0.015	LT	0.758	(19.253)	B	6	20	26	37	68	70	70
SCI-2120-014	—	1	150	—	100	—	10.00	1.000	0.003	LB	0.450	(11.430)	B	14	28	34	44	52	70	70
51-353-110	—	1	250	—	200	125	1.00	0.250	0.250	LT	0.758	(19.253)	A	—	17	29	50	70	70	70
†51-353-111	—	1	250	—	200	125	1.00	0.250	0.250	LB	0.758	(19.253)	A	—	17	29	50	70	70	70
51-353-112	—	1	250	—	200	125	3.00	0.250	0.050	LT	0.758	(19.253)	A	—	13	20	35	70	70	70
†51-353-113	—	1	250	—	200	125	3.00	0.250	0.050	LB	0.758	(19.253)	A	—	13	20	35	70	70	70
51-353-114	—	1	250	—	200	125	5.00	0.250	0.015	LT	0.758	(19.253)	A	—	12	20	30	62	70	70
51-353-116	—	1	250	—	200	125	10.00	0.250	0.010	LT	0.450	(11.430)	A	—	15	20	30	50	70	70
SCI-2320-010	—	1	300	—	300	125	0.50	0.150	1.000	LB	0.758	(19.253)	B	—	23	35	56	70	70	70
SCI-2320-004	—	1	300	—	300	125	1.00	0.150	0.250	LB	0.758	(19.253)	A	—	10	21	41	70	70	70
SCI-2320-005	—	1	300	—	300	125	2.00	0.150	0.063	LB	0.758	(19.253)	A	—	8	14	30	70	70	70
SCI-2320-006	—	1	300	—	300	125	3.00	0.150	0.027	LB	0.758	(19.253)	A	—	8	14	26	64	70	70
SCI-2320-007	—	1	300	—	300	125	10.00	0.150	0.003	LB	0.450	(11.430)	A	—	8	14	25	45	52	70
SCI-2320-014	—	1	300	—	300	125	10.00	0.150	0.003	LB	0.450	(11.430)	B	—	8	14	25	45	52	70

Low Pass Filters

.375 ø L Circuit MIL Qualified Profile

(See MIL index on pages 244-246 for complete MIL part number listing)

Part Number	M15733 MIL No	See Pg. 88 for Fig	Rated Voltage				I Amp	Min Cap µF	DCR Max Ohms	CKT	Max L		Thd Lgth	Minimum Insertion Loss (dB)						
			85°C		125°C						In	(mm)		30 KHz	150 KHz	300 KHz	1 MHz	10 MHz	100 MHz	1 GHz
			DC	AC	DC	AC														
51-390-018	23-0026	1	—	—	50	—	0.50	1.400	0.360	LB	0.630	(16.002)	A	12	36	48	69	70	70	70
51-390-026	23-0038	1	—	—	50	—	1.00	1.400	0.140	LB	0.630	(16.002)	A	11	26	36	55	70	70	70
51-390-034	23-0050	1	—	—	50	—	2.00	1.400	0.070	LB	0.630	(16.002)	A	10	24	32	48	70	70	70
†51-353-067	24-0006	1	80	—	50	—	10.00	1.400	0.010	LB	0.760	(19.304)	B	15	28	31	42	56	70	70
51-353-207	34-0007	1	—	—	50	—	10.00	1.400	0.010	LB	0.760	(19.304)	A	15	28	31	42	56	70	70
51-444-072	58-0002	1	80	—	50	—	10.00	1.400	0.008	LT	0.545	(13.843)	A	15	28	33	44	60	70	70
†51-353-066	24-0005	1	80	—	50	—	10.00	1.400	0.010	LB	0.760	(19.304)	A	15	28	31	42	56	70	70
51-353-287	39-0014	1	—	—	50	—	10.00	1.400	0.003	LT	0.760	(19.304)	B	14	28	34	44	52	70	70
†51-444-060	24-0008	1	80	—	50	—	10.00	1.400	0.010	LT	0.740	(18.796)	B	15	28	31	42	56	70	70
†51-343-028	38-0002	1	—	—	50	—	15.00	1.400	0.008	LB	0.481	(12.217)	A	15	28	33	44	64	70	70
†51-343-034	38-0006	1	—	—	50	—	15.00	1.400	0.008	LB	0.481	(12.217)	B	15	28	33	44	64	70	70
51-353-053	25-0003	1	—	—	100	—	1.00	0.450	0.250	LB	0.738	(18.745)	A	6	23	34	55	70	70	70
†51-353-054	25-0005	1	—	—	100	—	5.00	0.450	0.015	LT	0.758	(19.253)	A	6	17	23	35	69	70	70
†51-353-055	25-0008	1	—	—	100	—	5.00	0.450	0.015	LB	0.738	(18.745)	A	6	17	23	35	69	70	70
51-353-155	39-0008	1	—	—	100	—	5.00	0.450	0.015	LB	0.760	(19.304)	A	6	20	26	35	60	60	70
51-444-039	25-0017	1	—	—	100	—	5.00	0.450	0.015	LT	0.758	(19.253)	B	6	17	23	35	69	70	70

† Also available through Spectrum Control's authorized distributors.

Hermetically Sealed Threaded Case Filters

L-C Filter LT



L-C Filter LB



.375 ø L Circuit MIL Qualified Profile *continued*

(See MIL index on pages 244-246 for complete MIL part number listing)

Part Number	M15733 MIL No	See Pg. 88 for Fig	Rated Voltage				I Amp	Min Cap μ F	DCR Max Ohms	CKT	Max L In (mm)	Thd Lgth	Minimum Insertion Loss (dB)							
			85°C		125°C								30 KHz	150 KHz	300 KHz	1 MHz	10 MHz	100 MHz	1 GHz	
			DC	AC	DC	AC														
51-444-040	25-0020	1	—	—	100		5.00	0.450	0.015	LB	0.738 (18.745)	B	6	17	23	35	69	70	70	
51-353-156	39-0009	1	—	—	100		10.00	0.450	0.003	LT	0.760 (19.304)	A	6	20	26	35	56	60	70	
51-353-157	39-0010	1	—	—	100		10.00	0.450	0.003	LB	0.760 (19.304)	A	6	20	26	35	56	60	70	
+ 51-353-076	26-0001	1	—	—	150	125	1.00	0.250	0.250	LT	0.758 (19.253)	A	—	13	24	45	80	70	70	
+ 51-353-077	26-0003	1	—	—	150	125	1.00	0.250	0.250	LB	0.738 (18.745)	A	—	13	24	45	80	70	70	
51-444-043	26-0013	1	—	—	150	125	1.00	0.250	0.250	LT	0.758 (19.253)	B	—	13	24	45	80	70	70	
51-444-044	26-0015	1	—	—	150	125	1.00	0.250	0.250	LB	0.738 (18.745)	B	—	13	24	45	80	70	70	
51-390-040	23-0058	1	—	—	150		2.00	0.250	0.070	LT	0.630 (16.002)	A	3	15	23	38	60	70	60	
51-390-039	23-0057	1	—	—	150		2.00	0.250	0.070	LT	0.630 (16.002)	B	3	15	23	38	60	70	60	
51-444-005	34-0015	1	—	—	150	125	3.00	0.150	0.050	LT	0.758 (19.253)	B	—	8	15	30	68	70	70	
+ 51-353-078	26-0004	1	—	—	150	125	3.00	0.250	0.050	LT	0.758 (19.253)	A	—	8	15	30	68	70	70	
+ 51-353-079	26-0006	1	—	—	150	125	3.00	0.250	0.050	LB	0.738 (18.745)	A	—	8	15	30	68	70	70	
+ 51-444-046	26-0018	1	—	—	150	125	3.00	0.250	0.050	LB	0.738 (18.745)	B	—	8	15	30	68	70	70	
51-444-047	26-0019	1	—	—	150	125	5.00	0.250	0.015	LT	0.758 (19.253)	B	—	8	14	25	58	70	70	
+ 51-353-080	26-0007	1	—	—	150	125	5.00	0.250	0.015	LT	0.758 (19.253)	A	—	8	14	25	58	70	70	
51-353-081	26-0010	1	—	—	150	125	5.00	0.250	0.015	LB	0.738 (18.745)	A	—	8	14	25	58	70	70	
51-444-027	34-0030	1	—	—	200	125	5.00	0.250	0.150	LB	0.900 (22.860)	A	2	15	21	32	60	70	70	
51-444-117	54-0018	2	—	—	300	125	1.00	0.150	0.250	LB	0.740 (18.796)	A	—	10	21	41	70	70	70	

† Also available through Spectrum Control's authorized distributors.

Hermetically Sealed Threaded Case Filters



.375 ø Pi Circuit

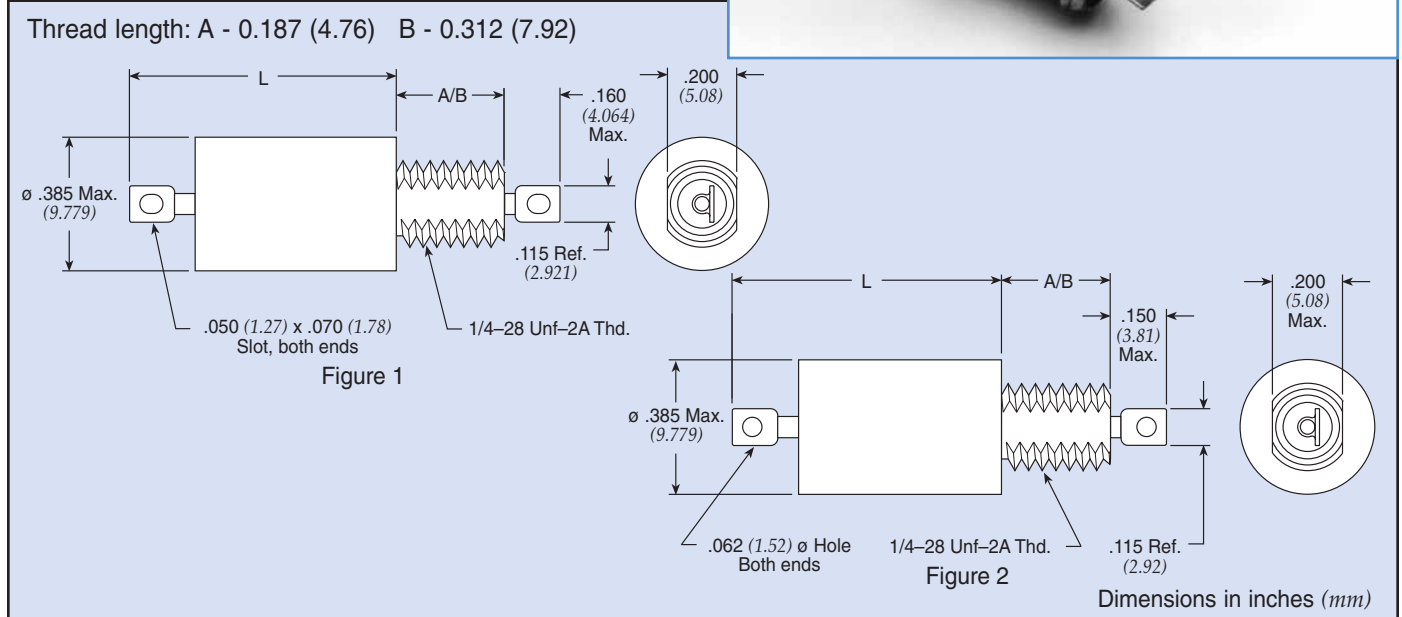

.375 ø Pi Circuit Standard Product

Part Number	MIL No	Figure	Rated Voltage				I Amp	Min Cap µF	DCR Max Ohms	Max L		Thd Lgth	Minimum Insertion Loss (dB)						
			DC	AC	DC	AC				In	(mm)		30 KHz	150 KHz	300 KHz	1 MHz	10 MHz	100 MHz	1 GHz
SCI-2030-010	—	2	80	—	50	—	0.50	1.500	1.000	0.758	(19.253)	B	24	66	70	70	70	70	
SCI-2030-004	—	2	80	—	50	—	1.00	1.500	0.250	0.758	(19.253)	A	15	54	70	70	70	70	
SCI-2030-005	—	2	80	—	50	—	2.00	1.500	0.063	0.758	(19.253)	A	—	45	62	70	70	70	
SCI-2030-006	—	2	80	—	50	—	3.00	1.500	0.027	0.758	(19.253)	A	—	35	55	70	70	70	
SCI-2030-013	—	2	80	—	50	—	3.00	1.500	0.027	0.758	(19.253)	B	—	35	55	70	70	70	
†9001-100-1080	—	1	80	—	50	—	5.00	2.800	0.015	0.758	(19.253)	A	—	18	60	70	70	70	
†9001-100-1081	—	1	80	—	50	—	10.0	2.800	0.005	0.758	(19.253)	A	21	32	40	35	68	70	70
SCI-2130-009	—	1	150	—	100	—	0.25	1.000	4.000	0.758	(19.253)	B	28	70	70	70	70	70	
51-311-319	—	1	150	—	100	—	0.50	1.000	0.600	0.758	(19.253)	A	—	51	69	70	70	70	
†9001-100-1010	—	1	150	—	100	—	0.50	1.000	0.600	0.758	(19.253)	A	6	39	68	70	70	70	
51-311-320	—	1	150	—	100	—	1.00	1.000	0.250	0.758	(19.253)	A	—	41	60	70	70	70	
†9001-100-1013	—	1	150	—	100	—	1.00	1.000	0.250	0.758	(19.253)	A	—	28	59	70	70	70	
51-311-321	—	1	150	—	100	—	3.00	1.000	0.060	0.758	(19.253)	A	—	16	41	70	70	70	
†51-311-322	—	1	150	—	100	—	5.00	1.000	0.015	0.758	(19.253)	A	—	—	28	65	70	70	
SCI-2130-007	—	1	150	—	100	—	10.0	1.000	0.003	0.758	(19.253)	A	9	24	29	40	70	70	
SCI-2130-014	—	1	150	—	100	—	10.0	1.000	0.005	0.758	(19.253)	B	9	24	29	40	70	70	
51-311-316	—	1	250	125	200	125	1.00	0.300	0.250	0.758	(19.253)	A	—	20	40	70	70	70	
51-311-317	—	1	250	125	200	125	3.00	0.300	0.050	0.758	(19.253)	A	—	—	20	55	70	70	
†9001-100-1025	—	1	250	125	200	125	5.00	0.300	0.015	0.758	(19.253)	A	—	—	12	50	70	70	80
SCI-2330-009	—	1	300	125	300	125	0.25	0.300	4.000	0.758	(19.253)	B	8	50	66	70	70	70	
SCI-2330-010	—	1	300	125	300	125	0.50	0.300	1.000	0.758	(19.253)	B	—	40	56	70	70	70	
SCI-2330-012	—	1	300	125	300	125	2.00	0.300	0.063	0.758	(19.253)	B	—	18	33	63	70	70	
SCI-2330-007	—	1	300	125	300	125	10.0	0.300	0.003	0.758	(19.253)	A	—	14	20	30	70	70	

† Also available through Spectrum Control's authorized distributors.

Hermetically Sealed Threaded Case Filters

.375 ø Pi Circuit MIL Qualified Product

(See MIL index on pages 244-246 for complete MIL part number listing)

Part Number	M15733 MIL No	See Pg. 91 for Fig.	Rated Voltage				I Amp	Min Cap µF	DCR Max Ohms	Max L		Thd Lgth	Minimum Insertion Loss (dB)						
			85°C		125°C					In	(mm)		30 KHz	150 KHz	300 KHz	1 MHz	10 MHz	100 MHz	1 GHz
			DC	AC	DC	AC													
51-390-305	23-0017	1	—	—	50	—	0.30	2.800	0.770	0.730	(18.542)	B	29	73	80	80	80	80	
51-390-314	23-0042	1	—	—	50	—	1.00	2.800	0.140	0.730	(18.542)	A	8	52	71	80	80	80	80
† 51-390-318	23-0054	1	—	—	50	—	2.00	1.500	0.070	0.730	(18.542)	A	—	46	65	80	80	80	80
† 51-390-317	23-0053	1	—	—	50	—	2.00	1.500	0.070	0.730	(18.542)	B	—	46	65	80	80	80	80
51-311-311	25-0010	1	—	—	100	—	0.25	0.900	1.500	0.793	(20.142)	A	—	48	66	80	80	80	70
† 51-311-308	25-0002	1	—	—	100	—	1.00	0.500	0.250	0.793	(20.142)	A	—	33	52	80	80	80	70
† 51-311-309	25-0004	1	—	—	100	—	3.00	0.660	0.050	0.793	(20.142)	A	—	17	34	68	80	80	70
† 51-311-310	25-0006	1	—	—	100	—	5.00	0.900	0.015	0.793	(20.142)	A	—	—	17	57	80	80	70
51-353-344	39-0011	1	—	—	100	—	10.0	0.990	0.003	0.760	(19.304)	A	9	24	29	40	70	70	70
51-353-345	39-0012	1	—	—	100	—	10.0	0.990	0.003	0.760	(19.304)	A	9	24	29	40	70	70	70
† 51-311-314	26-0011	1	—	—	150	125	0.25	0.300	1.500	0.793	(20.142)	A	—	29	47	70	80	80	70
51-390-312	23-0036	1	—	—	150	—	0.50	0.500	0.360	0.730	(18.542)	A	—	48	66	70	70	70	70
51-390-311	23-0035	1	—	—	150	—	0.50	0.500	0.360	0.730	(18.542)	B	—	48	66	70	70	70	70
† 51-353-336	26-0002	1	—	—	150	125	1.00	0.300	0.250	0.793	(20.142)	A	—	11	32	63	80	80	70
51-390-315	23-0047	1	—	—	150	—	1.00	0.500	0.140	0.730	(18.542)	B	—	32	51	70	70	70	70
51-311-312	26-0005	1	—	—	150	125	3.00	0.300	0.050	0.793	(20.142)	A	—	5	6	47	80	80	70
51-311-408	54-0005	2	—	—	300	115	1.00	0.300	0.250	0.761	(19.329)	A	—	23	43	70	70	70	70

† Also available through Spectrum Control's authorized distributors.

Transient Suppression Pi Filters

Part Number	See Pg. 91 for Fig.	Rated Volt. VDC	I Amp	Min Cap µF	DCR Min Mohms	Max RDC Ohms	Transient Suppressor*				Length		Max Thd Lgth	Minimum Insertion Loss (dB)						
							VR* (VDC)	BV* (VDC)	IT* (MA)	IPP* (A)	In	(mm)		30 KHz	300 KHz	1 MHz	10 MHz	100 MHz	1 GHz	
51-570-300	1	5	0.50	1.400	0.500	0.600	6.5	7.22/7.98	10	44.7	1.179	(29.947)	A	23	57	70	70	70	70	
51-570-301	1	5	1.00	1.400	0.500	0.350	6.5	7.22/7.98	10	44.7	1.179	(29.947)	A	3	47	70	70	70	70	
51-570-302	1	5	3.00	1.400	0.500	0.060	6.5	7.22/7.98	10	44.7	1.179	(29.947)	A	—	23	58	70	70	70	
51-570-303	1	5	5.00	1.400	0.500	0.015	6.5	7.22/7.98	10	44.7	1.179	(29.947)	A	—	17	48	70	70	70	
51-570-304	1	5	10.00	1.400	0.500	0.005	6.5	7.22/7.98	10	44.7	1.179	(29.947)	A	16	26	35	40	60	70	
51-570-310	1	28	0.50	1.400	30.000	0.600	33.0	36.7/40.6	1	9.4	1.179	(29.947)	A	23	57	70	70	70	70	
51-570-311	1	28	1.00	1.400	30.000	0.350	33.0	36.7/40.6	1	9.4	1.179	(29.947)	A	3	47	70	70	70	70	
51-570-312	1	28	3.00	1.400	30.000	0.060	33.0	36.7/40.6	1	9.4	1.179	(29.947)	A	—	23	58	70	70	70	
51-570-313	1	28	5.00	1.400	30.000	0.015	33.0	36.7/40.6	1	9.4	1.179	(29.947)	A	—	17	48	70	70	70	
51-570-314	1	28	10.00	1.400	30.000	0.005	33.0	36.7/40.6	1	9.4	1.179	(29.947)	A	16	26	35	40	60	70	
51-570-320	1	50	0.50	1.400	50.000	0.600	58.0	64.4/71.2	1	5.3	1.179	(29.947)	A	23	57	70	70	70	70	
51-570-321	1	50	1.00	1.400	50.000	0.350	58.0	64.4/71.2	1	5.3	1.179	(29.947)	A	3	47	70	70	70	70	
51-570-322	1	50	3.00	1.400	50.000	0.060	58.0	64.4/71.2	1	5.3	1.179	(29.947)	A	—	23	58	70	70	70	
51-570-323	1	50	5.00	1.400	50.000	0.015	58.0	64.4/71.2	1	5.3	1.179	(29.947)	A	—	17	48	70	70	70	
51-570-324	1	50	10.00	1.400	50.000	0.005	58.0	64.4/71.2	1	5.3	1.179	(29.947)	A	16	26	35	40	60	70	

* Transient Suppression definitions and ratings

VR = Reverse standoff voltage
BV = Breakdown voltage

IPP = Max. peak pulse current
IT = Test current

Hermetically Sealed Threaded Case Filters



.375 ø T Circuit

Thread length: A - 0.187 (4.76) B - 0.312 (7.92)

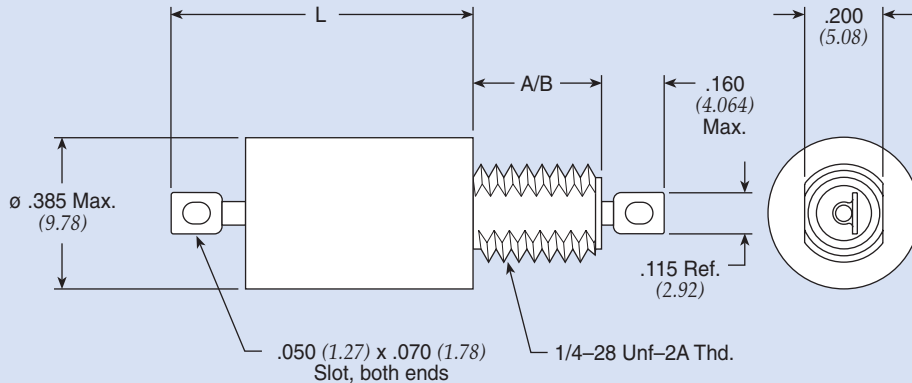

Figure 1

Note: Max. O.D. is ø .416" for Military QPL Filters.

Dimensions in inches (mm)

.375 ø T Circuit Standard Product

Part Number	MIL No	Figure	Rated Voltage				I Amp	Min Cap μ F	DCR Max Ohms	Max L		Thd Lgth	Minimum Insertion Loss (dB)						
			85°C		125°C					In	(mm)		30 KHz	150 KHz	300 KHz	1 MHz	10 MHz	100 MHz	1 GHz
SCI-2040-012	—	1	80	—	50	—	2.00	1.400	0.126	1.071	(27.203)	B	8	22	30	55	70	70	70
SCI-2040-013	—	1	80	—	50	—	3.00	1.400	0.054	1.071	(27.203)	B	8	22	28	43	70	70	70
† 9004-100-2017	—	1	80	—	50	—	15.0	1.400	0.005	1.179	(29.947)	A	17	27	34	44	60	70	70
SCI-2140-004	—	1	150	—	100	—	1.00	0.500	0.500	1.070	(27.178)	A	4	25	40	70	70	70	70
SCI-2140-006	—	1	150	—	100	—	3.00	0.500	0.054	1.071	(27.203)	A	4	19	24	39	70	70	70
SCI-2140-007	—	1	150	—	100	—	10.0	0.500	0.010	1.071	(27.203)	A	4	19	24	34	57	70	70
SCI-2340-009	—	1	300	—	300	125	0.25	0.150	8.000	1.071	(27.203)	B	11	57	70	70	70	70	70
SCI-2340-004	—	1	300	—	300	125	1.00	0.150	0.500	1.071	(27.203)	A	—	13	29	59	70	70	70
SCI-2340-013	—	1	300	—	300	125	3.00	0.150	0.054	1.071	(27.203)	B	—	8	14	29	70	70	70
SCI-2340-014	—	1	300	—	300	125	10.0	0.150	0.010	1.071	(27.203)	B	—	8	14	24	47	70	70

† Also available through Spectrum Control's authorized distributors.

(See MIL index on page 244-246 for complete MIL part number listing)

.375 ø T Circuit MIL Qualified Product

Part Number	M15733 MIL No	Figure	Rated Voltage				I Amp	Min Cap μ F	DCR Max Ohms	Max L		Thd Lgth	Minimum Insertion Loss (dB)						
			85°C		125°C					In	(mm)		30 KHz	150 KHz	300 KHz	1 MHz	10 MHz	100 MHz	1 GHz
51-382-609	25-0024	1	—	—	100	—	2.00	0.750	0.100	1.179	(29.947)	B	10	22	31	55	80	70	70
51-382-603	25-0007	1	—	—	100	—	4.00	0.750	0.063	1.345	(34.163)	A	10	22	28	43	80	70	70
† 51-351-604	26-0012	1	—	—	150	125	2.00	0.250	0.100	1.179	(29.947)	A	—	13	21	43	80	70	70
51-351-603	26-0008	1	—	—	150	125	4.00	0.250	0.063	1.345	(34.163)	A	—	11	18	33	80	70	70

† Also available through Spectrum Control's authorized distributors.

Hermetically Sealed Threaded Case Filters

.375 ø TT Circuit Standard Product

Part Number	MIL No	See Pg. 93 for Fig.	Rated Voltage				I Amp	Min Cap μ F	DCR Max Ohms	Max L		Thd Lgth	Minimum Insertion Loss (dB)						
			85°C		125°C					In	(mm)		30 KHz	150 KHz	300 KHz	1 MHz	10 MHz	100 MHz	1 GHz
			DC	AC	DC	AC													
SCI-2060-009	—	1	—	—	50	—	0.25	1.500	12.000	1.241	(31.521)	B	70	70	70	70	70	70	70
SCI-2060-013	—	1	—	—	50	—	3.00	1.500	0.081	1.241	(31.521)	B	—	33	54	70	70	70	70
SCI-2060-007	—	1	—	—	50	—	10.0	1.500	0.006	1.241	(31.521)	A	15	29	35	42	55	70	70
SCI-2060-014	—	1	—	—	50	—	10.0	1.500	0.006	1.241	(31.521)	B	15	29	35	42	55	70	70
SCI-2160-011	—	1	—	—	100	—	1.00	1.500	0.750	1.241	(31.521)	B	12	52	70	70	70	70	70
SCI-2160-012	—	1	—	—	100	—	2.00	1.500	0.189	1.241	(31.521)	B	—	33	56	70	70	70	70
SCI-2160-013	—	1	—	—	100	—	3.00	1.500	0.081	1.241	(31.521)	B	—	24	54	70	70	70	70
SCI-2160-014	—	1	—	—	100	—	10.0	1.400	0.006	1.241	(31.521)	B	12	25	32	42	55	70	70
SCI-2360-011	—	1	—	—	300	125	1.00	0.500	0.750	1.241	(31.521)	B	—	48	70	70	70	70	70
SCI-2360-006	—	1	—	—	300	125	3.00	0.500	0.080	1.241	(31.521)	A	—	12	38	70	70	70	70
SCI-2360-007	—	1	—	—	300	125	10.0	0.500	0.006	1.241	(31.521)	A	5	18	24	34	55	70	70
SCI-2360-014	—	1	—	—	300	125	10.0	0.500	0.006	1.241	(31.521)	B	5	18	24	34	55	70	70

Hermetically Sealed Threaded Case Filters



.690 ø C Circuit

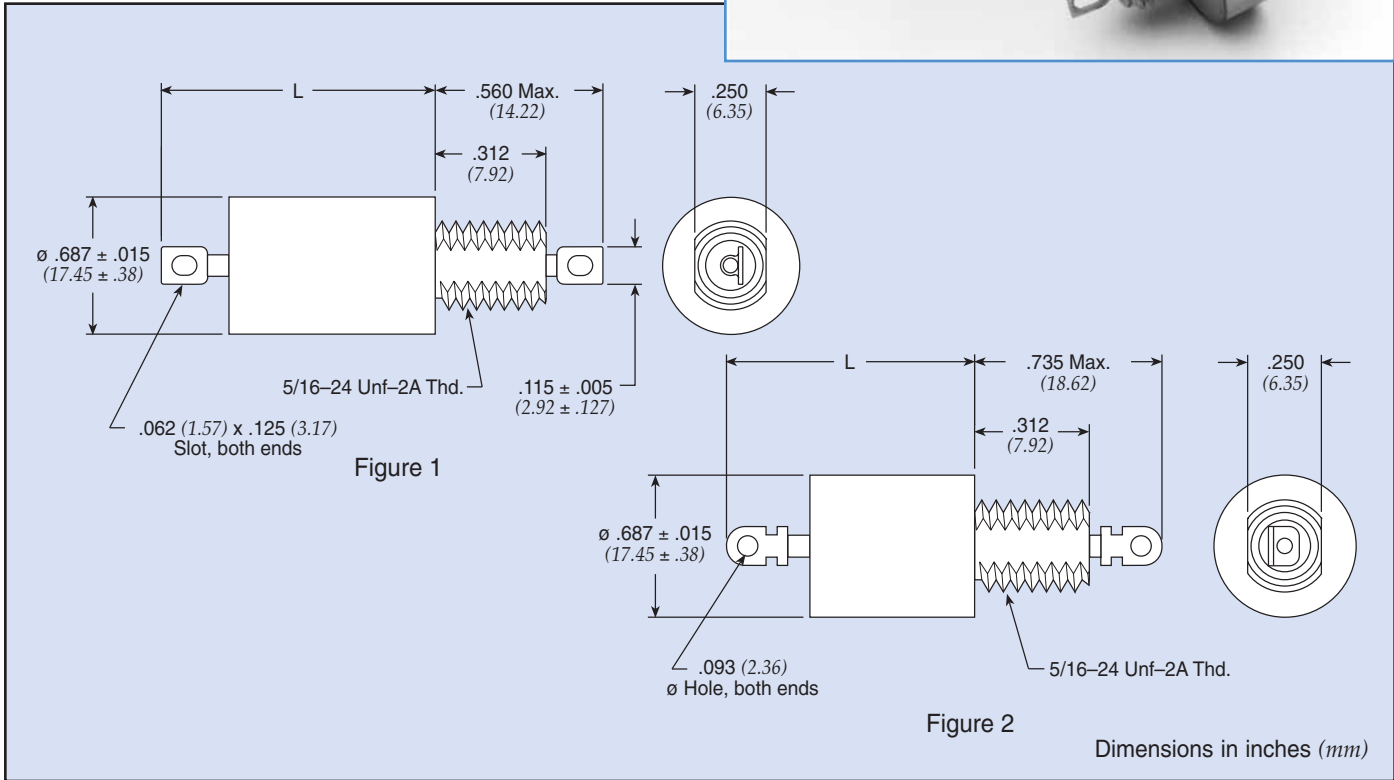

.690 ø C Circuit Standard Product

Part Number	MIL No	Figure	Rated Voltage				I Amp	Min Cap µF	DCR Max Ohms	Max L		Minimum Insertion Loss (dB)						
			85°C		125°C					In	(mm)	30 KHz	150 KHz	300 KHz	1 MHz	10 MHz	100 MHz	1 GHz
†9932-100-6004	—	1	200	—	150	125	15	2.600	0.005	0.702	(17.831)	10	29	39	50	60	70	70
54-310-001	—	1	300	—	300	125	15	0.500	0.005	0.560	(14.224)	6	19	25	36	50	70	70
54-310-005	—	2	250	—	200	125	25	0.500	0.005	0.750	(19.050)	6	19	25	36	50	70	70
54-310-009	—	1	450	240	400	240	15	0.250	0.005	0.560	(14.224)	—	14	19	30	45	60	70
†9932-100-6005	—	1	450	240	400	240	15	0.250	0.005	0.560	(14.224)	—	14	19	30	50	70	70

.690 ø C Circuit MIL Qualified Product

Part Number	M15733 MIL No	Figure	Rated Voltage				I Amp	Min Cap µF	DCR Max Ohms	Max L		Minimum Insertion Loss (dB)						
			85°C		125°C					In	(mm)	30 KHz	150 KHz	300 KHz	1 MHz	10 MHz	100 MHz	1 GHz
54-310-039	34-0037	1	—	—	275	125	15	0.200	0.005	0.575	(14.605)	5	15	21	31	51	70	70

.690 ø C Circuit DSCC 84084 Product

Part Number	84084 No	Figure	Rated Voltage				I Amp	Min Cap µF	DCR Max Ohms	Max L		Minimum Insertion Loss (dB)						
			85°C		125°C					In	(mm)	30 KHz	150 KHz	300 KHz	1 MHz	10 MHz	100 MHz	1 GHz
54-310-042	-001	1	—	—	400	230	15	0.150	0.005	0.700	(17.780)	—	10	16	26	40	52	70

† Also available through Spectrum Control's authorized distributors.

Hermetically Sealed Threaded Case Filters



.690 ø L Circuit

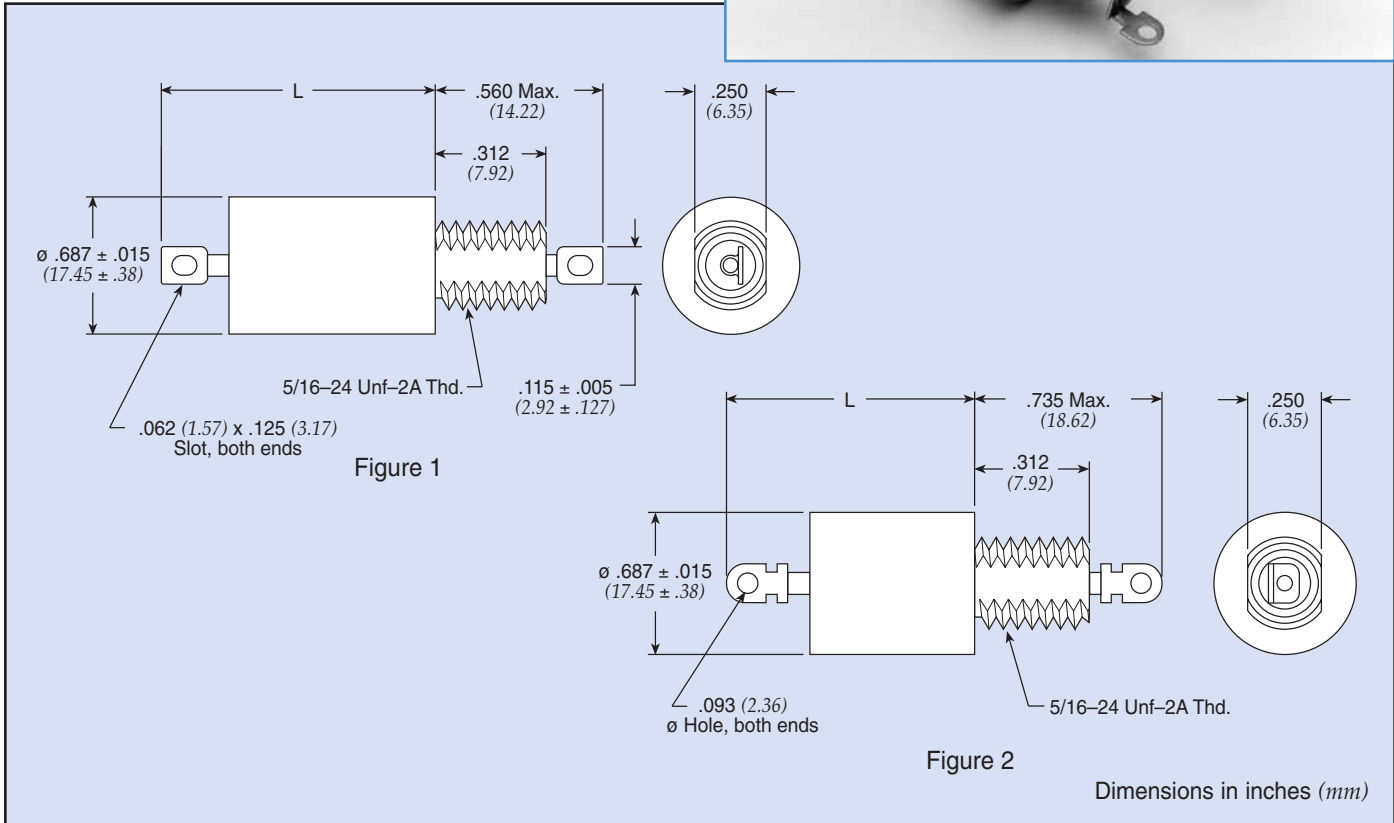

.690 ø L Circuit Standard Product

Part Number	MIL No	Figure	Rated Voltage				I Amp	Min Cap µF	DCR Max Ohms	CKT	Max L		Minimum Insertion Loss (dB)						
			85°C		125°C						In	L (mm)	30 KHz	150 KHz	300 KHz	1 MHz	10 MHz	100 MHz	1 GHz
			DC	AC	DC	AC													
9010-100-0049	—	1	150	—	100	—	10.0	1.400	0.005	LT	0.905	(22.987)	16	24	34	44	60	70	70
SCI-6120-008	—	1	150	—	100	—	10.0	2.600	0.006	LB	0.959	(24.359)	18	32	39	49	70	70	70
SCI-6120-009	—	1	150	—	100	—	20.0	2.600	0.001	LB	0.905	(22.987)	18	32	39	49	60	70	70
51-320-041	—	1	250	—	200	125	10.0	0.500	0.008	LT	0.905	(22.987)	5	19	25	35	50	70	70
51-320-024	—	1	450	240	400	240	1.00	0.360	0.210	LT	0.905	(22.987)	5	30	38	60	70	70	70
51-320-100	—	1	450	240	400	240	1.00	0.250	0.210	LT	0.905	(22.987)	—	21	33	55	70	70	70
† 51-320-026	—	1	450	240	400	240	3.00	0.360	0.030	LT	0.905	(22.987)	5	19	25	45	70	70	70
51-320-103	—	1	450	240	400	240	5.00	0.360	0.010	LB	0.905	(22.987)	—	12	18	30	60	70	70
51-322-007	—	1	450	240	400	240	15.0	0.360	0.007	LB	0.650	(16.510)	5	19	25	35	48	62	70
51-322-015	—	2	450	240	400	240	25.0	0.360	0.007	LT	0.750	(19.050)	5	17	23	34	48	62	70
51-322-036	—	2	450	240	400	240	25.0	0.250	0.007	LB	0.750	(19.050)	—	10	16	29	45	60	70
9010-100-0054	—	1	450	240	300	240	1.00	0.150	0.250	LT	0.905	(22.987)	—	14	32	52	70	70	70
SCI-6320-004	—	1	300	—	300	125	1.00	0.400	0.300	LB	0.959	(24.359)	6	24	35	56	70	70	70

† Also available through Spectrum Control's authorized distributors.

Hermetically Sealed Threaded Case Filters

L-C Filter LT

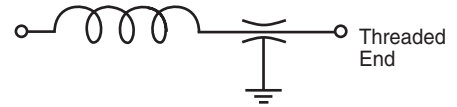

L-C Filter LB



(See MIL index on page 244-246 for complete MIL part number listing)

.690 ø L Circuit MIL Qualified Product

Part Number	M15733 MIL No	See Pg. 96 for Fig.	Rated Voltage				I Amp	Min Cap µF	DCR Max Ohms	CKT	Max L		Minimum Insertion Loss (dB)							
			85°C		125°C						In	(mm)	30 KHz	150 KHz	300 KHz	1 MHz	10 MHz	100 MHz	1 GHz	
			DC	AC	DC	AC							—	—	—	—	—	—	—	—
† 51-320-015	27-0005	1	—	—	200	125	3.00	0.250	0.033	LT	0.900	(22.860)	—	14	21	39	80	70	70	
51-320-017	27-0008	1	—	—	200	125	5.00	0.250	0.016	LT	0.900	(22.860)	—	13	19	32	69	70	70	
51-320-018	27-0009	1	—	—	200	125	5.00	0.250	0.016	LB	0.900	(22.860)	—	13	19	32	69	70	70	
51-323-003	27-0011	1	—	—	200	125	10.0	0.250	0.005	LT	1.031	(26.187)	—	13	19	30	61	70	70	
51-323-004	27-0012	1	—	—	200	125	10.0	0.250	0.005	LB	1.031	(26.187)	—	13	19	30	61	70	70	
† 51-322-009	27-0014	2	—	—	200	125	15.0	0.250	0.007	LT	1.763	(44.780)	—	19	25	36	60	70	70	
51-322-017	34-0002	2	—	—	200	125	20.0	0.360	0.050	LB	1.763	(44.780)	—	19	25	35	57	70	70	

.690 ø L Circuit DSCC 84084 Product

Part Number	84084 No	See Pg. 96 for Fig.	Rated Voltage				I Amp	Min Cap µF	DCR Max Ohms	CKT	Max L		Minimum Insertion Loss (dB)							
			85°C		125°C						In	(mm)	30 KHz	150 KHz	300 KHz	1 MHz	10 MHz	100 MHz	1 GHz	
			DC	AC	DC	AC							—	—	—	—	—	—	—	—
51-320-162	-004	1	—	—	400	230	1.00	0.150	0.150	LT	0.905	(22.987)	—	19	30	46	60	70	70	
51-320-163	-005	1	—	—	400	230	1.00	0.150	0.150	LB	0.905	(22.987)	—	19	30	46	60	70	70	
51-320-164	-006	1	—	—	400	230	3.00	0.150	0.026	LT	0.905	(22.987)	—	11	19	36	60	70	70	
51-320-165	-007	1	—	—	400	230	3.00	0.150	0.026	LB	0.905	(22.987)	—	11	19	36	60	70	70	
51-320-166	-008	1	—	—	400	230	5.00	0.150	0.013	LT	0.905	(22.987)	—	10	16	28	54	70	70	
51-320-167	-009	1	—	—	400	230	5.00	0.150	0.013	LB	0.905	(22.987)	—	10	16	28	54	70	70	
51-320-168	-010	1	—	—	400	230	10.0	0.150	0.008	LT	0.905	(22.987)	—	10	16	25	48	70	70	
51-320-169	-011	1	—	—	400	230	10.0	0.150	0.008	LB	0.905	(22.987)	—	10	16	25	48	70	70	

† Also available through Spectrum Control's authorized distributors.

Hermetically Sealed Threaded Case Filters

.690 ø Pi Circuit

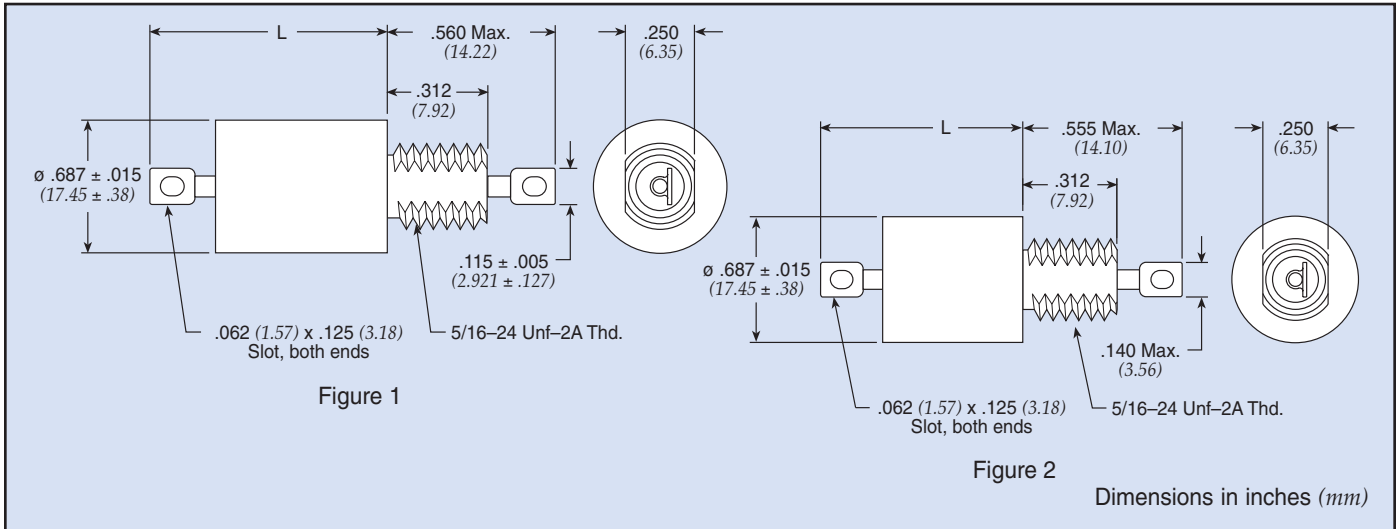

Low Pass Filters

.690 ø Pi Circuit Standard Product

Part Number	MIL No	Figure	Rated Voltage				I Amp	Min Cap µF	DCR Max Ohms	Max L		Minimum Insertion Loss (dB)						
			85°C		125°C					In	(mm)	30 KHz	150 KHz	300 KHz	1 MHz	10 MHz	100 MHz	1 GHz
51-321-322	—	1	150	—	100	—	1.00	2.800	0.210	1.195	(30.353)	35	69	70	70	70	70	70
SCI-6130-009	—	1	150	—	100	—	20.0	5.200	0.001	1.195	(30.353)	23	31	35	35	70	70	70
51-321-317	—	1	450	240	400	*240	1.00	0.720	0.400	1.195	(30.353)	—	53	70	70	70	70	70
†51-321-318	—	1	450	240	400	*240	3.00	0.720	0.030	1.195	(30.353)	—	31	51	70	70	70	70
†51-321-319	—	1	450	240	400	*240	5.00	0.720	0.020	1.195	(30.353)	—	11	30	65	70	70	70

* 0-60 Hz

(See MIL index on page 244-246 for complete MIL part number listing)

.690 ø Pi Circuit MIL Qualified Product

Part Number	M15733 MIL No	Figure	Rated Voltage				I Amp	Min Cap µF	DCR Max Ohms	Max L		Minimum Insertion Loss (dB)						
			85°C		125°C					In	(mm)	30 KHz	150 KHz	300 KHz	1 MHz	10 MHz	100 MHz	1 GHz
51-321-312	27-0004	1	—	—	200	125	1.00	0.500	0.250	1.195	(30.353)	—	47	65	80	80	70	70
51-323-313	27-0003	1	—	—	200	125	1.00	0.500	0.270	1.031	(26.187)	—	43	61	80	80	70	70
51-321-313	27-0010	1	—	—	200	125	5.00	0.500	0.024	1.195	(30.353)	—	10	28	64	80	70	70
†51-321-314	27-0013	1	—	—	200	125	10.0	0.500	0.008	1.195	(30.353)	—	16	18	48	80	70	70
51-321-329	34-0005	1	—	—	200	125	10.0	0.500	0.075	1.195	(30.353)	—	16	18	48	80	70	70

.690 ø Pi Circuit DSCC 84084 Product

Part Number	84084 No	Figure	Rated Voltage				I Amp	Min Cap µF	DCR Max Ohms	Max L		Minimum Insertion Loss (dB)						
			85°C		125°C					In	(mm)	30 KHz	150 KHz	300 KHz	1 MHz	10 MHz	100 MHz	1 GHz
51-321-398	-013	2	—	—	400	230	1.00	0.200	0.150	1.200	(30.480)	—	27	46	74	80	80	80
51-321-399	-014	2	—	—	400	230	3.00	0.200	0.026	1.200	(30.480)	—	—	30	60	80	80	80
51-321-400	-015	2	—	—	400	230	5.00	0.200	0.013	1.200	(30.480)	—	—	12	50	80	80	80
51-321-401	-016	2	—	—	400	230	10.0	0.200	0.008	1.200	(30.480)	—	—	—	30	80	80	80

† Also available through Spectrum Control's authorized distributors.

Hermetically Sealed Threaded Case Filters

.690 ø T Circuit

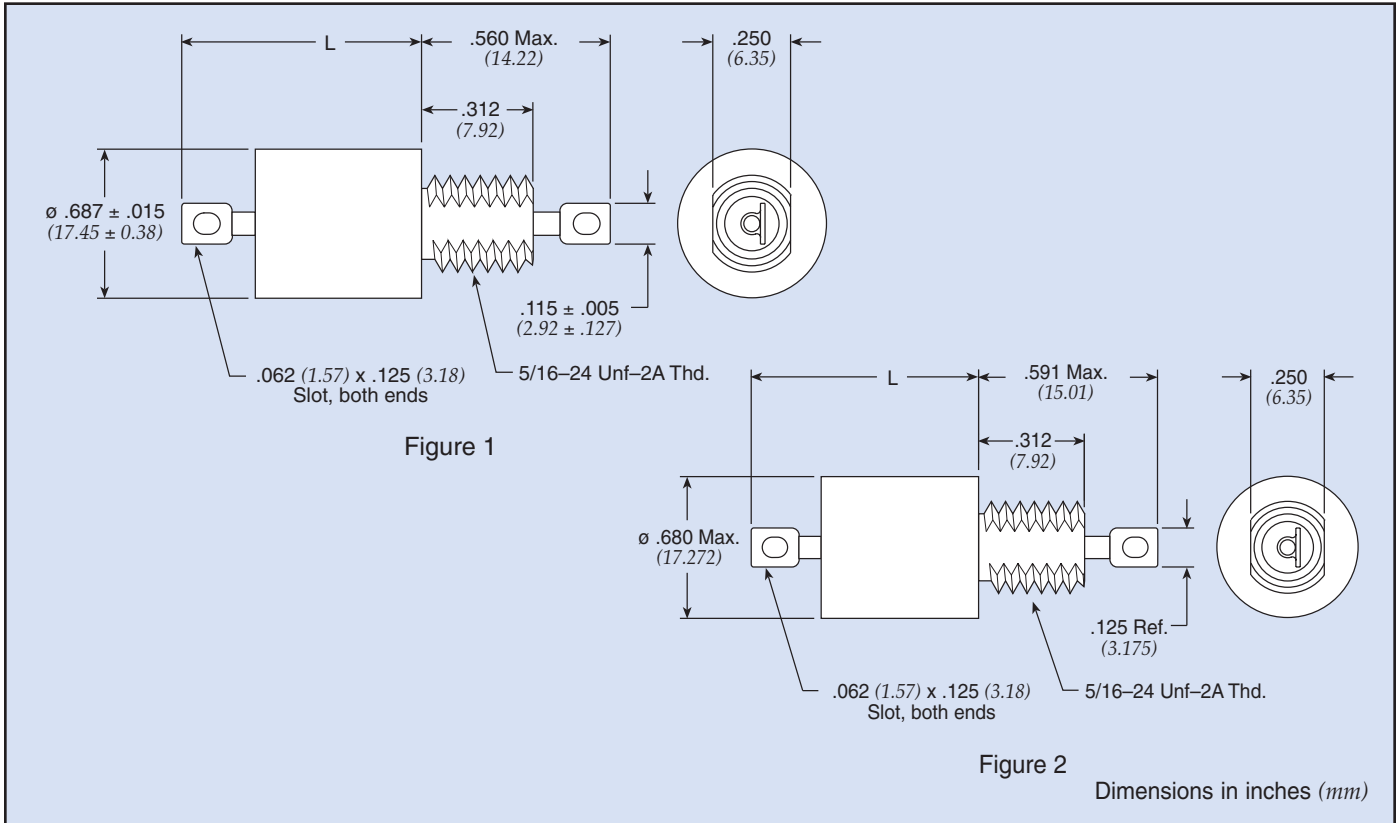

.690 ø T Circuit Standard Product

Part Number	MIL No	Figure	Rated Voltage				I Amp	Min Cap μ F	DCR Max Ohms	Max L (mm)		Minimum Insertion Loss (dB)						
			85°C		125°C							30 KHz	150 KHz	300 KHz	1 MHz	10 MHz	100 MHz	1 GHz
			DC	AC	DC	AC						In						
SCI-6140-004	—	1	150	—	100	—	1.00	2.600	0.600	1.195	(30.353)	23	54	70	70	70	70	70
SCI-6140-006	—	1	150	—	100	—	3.00	2.600	0.100	1.195	(30.353)	21	35	46	70	70	70	70
SCI-6140-007	—	1	150	—	100	—	5.00	2.600	0.060	1.195	(30.353)	21	34	41	58	70	70	70
SCI-6140-009	—	1	150	—	100	—	20.0	2.600	0.002	1.195	(30.353)	21	35	41	50	60	70	70
51-321-649	—	1	250	125	200	125	2.00	0.360	0.090	1.195	(30.353)	—	24	38	65	70	70	70
† 51-321-610	—	1	450	240	400	240	1.00	0.360	0.600	1.195	(30.353)	7	43	60	70	70	70	70

.690 ø T Circuit MIL Qualified Product

(See MIL index on pages 244-246 for complete MIL part number listing)

Part Number	M15733 MIL No	Figure	Rated Voltage				I Amp	Min Cap μ F	DCR Max Ohms	Max L (mm)		Minimum Insertion Loss (dB)						
			85°C		125°C							30 KHz	150 KHz	300 KHz	1 MHz	10 MHz	100 MHz	1 GHz
			DC	AC	DC	AC						In						
51-321-607	27-0017	1	—	—	200	125	1.50	0.250	0.133	1.195	(30.353)	—	19	32	62	70	70	70
51-321-608	27-0018	1	—	—	200	125	4.00	0.250	0.025	1.195	(30.353)	—	14	21	36	70	70	70
51-321-670	54-0017	2	—	—	300	115	10.0	0.500	0.006	1.177	(29.896)	5	20	23	35	60	70	60

† Also available through Spectrum Control's authorized distributors.

Value-Added Low Pass Filter Assemblies

Spectrum Control's value-added low pass filters provide flexible solutions to meet your unique design challenges. Our manufacturing process allows you to add connectors, modify terminations or add wire harnesses without adding much cost or drastically increasing lead times.

For custom requirements and exceptional needs, contact our design/manufacturing team.

Features

- Build-to-order low pass filters from Spectrum Control, Inc.
- Custom low pass filter assemblies

Benefits

- Incorporates specific terminations, connectors or wire harnesses to accommodate your application
- Lowers the cost of acquisition and assembly
- Reduces production operations and lead times
- Allows you to stream line your bill of materials
- Reduces inventory/production costs

